

**ProLight PM2B-1LxE
1W Power LED
Technical Datasheet
Version: 2.7**

Features

- High flux per LED
- Various colors
- Good color uniformity
- Industry best moisture sensitivity level - JEDEC Level 1
- Lead free reflow soldering
- RoHS compliant
- More energy efficient than incandescent and most halogen lamps
- Low Voltage DC operated
- Instant light (less than 100ns)
- No UV
- Superior ESD protection

Typical Applications

- Reading lights (car, bus, aircraft)
- Portable (flashlight, bicycle)
- Uplighters/Downlighters
- Decorative/Entertainment
- Bollards/Security/Garden
- Cove/Undershelf/Task
- Indoor/Outdoor Commercial and Residential Architectural
- Automotive Ext (Stop-Tail-Turn, CHMSL, Mirror Side Repeat)
- LCD backlights

Emitter Mechanical Dimensions

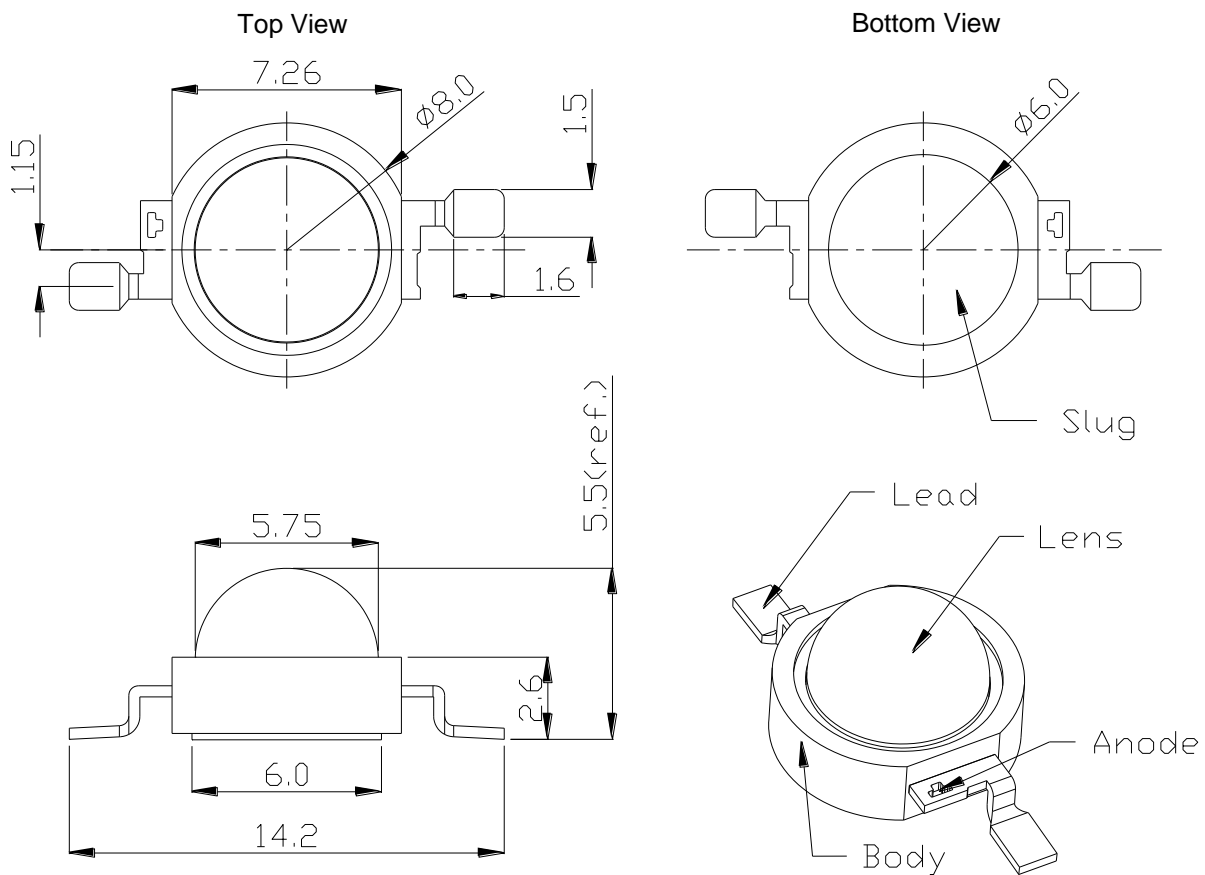

Circuit Diagram (W,W,G,C,B,D)

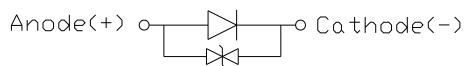

Circuit Diagram (R,A,M,E)

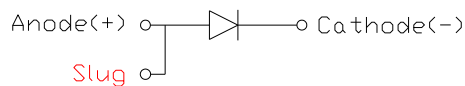

Notes:

1. The Anode side of the device is denoted by a hole in the lead frame.
2. Electrical insulation between the case and the board is required. Do not electrically connect either the anode or cathode to the slug.
3. Drawing not to scale.
4. All dimensions are in millimeters.
5. Unless otherwise indicated, tolerances are $\pm 0.20\text{mm}$.
6. Please do not bend the leads of the LED, otherwise it will damage the LED.
7. **Please do not use a force of over 3kgf impact or pressure on the lens of the LED, otherwise it will cause a catastrophic failure.**

*The appearance and specifications of the product may be modified for improvement without notice.

Flux Characteristics at 350mA, T_J = 25°C

Radiation Pattern	Color	Part Number Emitter	Lumious Flux or Power	
			Minimum	Typical
Lambertian	White	PM2B-1LWE	110 lm	152 lm
	Warm White	PM2B-1LVE	110 lm	146 lm
	Red	PM2B-1LRE	39.8 lm	52 lm
	Amber	PM2B-1LAE	39.8 lm	57 lm
	Green	PM2B-1LGE	76.6 lm	105 lm
	Cyan	PM2B-1LCE	58.9 lm	74 lm
	Blue	PM2B-1LBE	18.1 lm	24 lm
	Royal Blue	PM2B-1LDE	435 mW	560 mW
	Crimson	PM2B-1LME	225 mW	300 mW
	Cherry Red	PM2B-1LEE	175 mW	260 mW

- ProLight maintains a tolerance of $\pm 10\%$ on flux and power measurements.
- Please do not drive at rated current more than 1 second without proper heat sink.

Electrical Characteristics at 350mA, T_J = 25°C

Color	Forward Voltage V _F (V)			Thermal Resistance Junction to Slug (°C/ W)
	Min.	Typ.	Max.	
White	2.85	3.3	3.85	10
Warm White	2.85	3.3	3.85	10
Red	1.75	2.2	3.0	10
Amber	1.75	2.2	3.0	10
Green	2.85	3.4	3.85	10
Cyan	2.85	3.4	3.85	10
Blue	2.85	3.3	3.85	10
Royal Blue	2.85	3.3	3.85	10
Crimson	1.75	2.2	3.0	10
Cherry Red	1.50	2.0	2.75	10

- ProLight maintains a tolerance of $\pm 0.1V$ for Voltage measurements.

Optical Characteristics at 350mA, T_J = 25°C

Color	Dominant Wavelength λ_D , Peak Wavelength ^[1] λ_P , or Color Temperature CCT			Total included Angle (degrees) $\theta_{0.90V}$	Viewing Angle (degrees) $2 \theta_{1/2}$
	Min.	Typ.	Max.		
White	4100 K	5500 K	10000 K	180	130
Warm White	2700 K	3300 K	4100 K	180	130
Red	613.5 nm	623 nm	631 nm	180	130
Amber	587 nm	592 nm	597 nm	180	130
Green	515 nm	525 nm	535 nm	180	130
Cyan	495 nm	505 nm	515 nm	180	130
Blue	455 nm	465 nm	475 nm	180	130
Royal Blue	450 nm	455 nm	460 nm	180	130
Crimson ^[1] ^[2]	650 nm	660 nm	670 nm	180	130
Cherry Red ^[1]	720 nm	730 nm	740 nm	180	130

- ProLight maintains a tolerance of ± 1 nm for dominant wavelength measurements.
- ProLight maintains a tolerance of $\pm 5\%$ for CCT measurements.
- ^[1] Crimson, Cherry Red product is binned by peak wavelength rather than dominant wavelength.
- ^[2] The peak wavelength of 660nm should contain the dominant wavelength of around 640nm.

Absolute Maximum Ratings

Parameter	White/Warm White/Red/Amber/Green/ Cyan/Blue/Royal Blue/Crimson/Cherry Red
DC Forward Current (mA)	350
Peak Pulsed Forward Current (mA)	500 (less than 1/10 duty cycle@1KHz)
Average Forward Current (mA)	350
ESD Sensitivity (HBM per MIL-STD-883E Method 3015.7)	$\pm 4000V$ (Class III)
LED Junction Temperature	120°C
Operating Board Temperature at Maximum DC Forward Current	-40°C - 105°C
Storage Temperature	-40°C - 120°C
Soldering Temperature	JEDEC 020c 260°C
Allowable Reflow Cycles	3
Reverse Voltage	Not designed to be driven in reverse bias

Radiometric Power Bin Structure

Color	Bin Code	Minimum Radiometric Power (mW)	Maximum Radiometric Power (mW)	Available Color Bins
Royal Blue	Q	435	515	All
	R	515	635	All
	S	635	755	[¹]
Crimson	M	225	275	All
	N	275	335	[¹]
	P	335	435	[¹]
Cherry Red	L	175	225	All
	M	225	275	All
	N	275	335	[¹]

- ProLight maintains a tolerance of $\pm 10\%$ on flux and power measurements.
- The flux bin of the product may be modified for improvement without notice.
- [¹] The rest of color bins are not 100% ready for order currently. Please ask for quote and order possibility.

Photometric Luminous Flux Bin Structure

Color	Bin Code	Minimum Photometric Flux (lm)	Maximum Photometric Flux (lm)	Available Color Bins
White	V1	110	120	[¹]
	V2	120	130	All
	W1	130	140	All
	W2	140	155	All
	X1	155	170	Xx,Wx,Vx [¹]
Warm White	V1	110	120	All
	V2	120	130	All
	W1	130	140	All
	W2	140	155	All
	X1	155	170	[¹]
Red	R	39.8	51.7	All
	S1	51.7	58.9	All
	S2	58.9	67.2	[¹]
	T1	67.2	76.6	[¹]
Amber	R	39.8	51.7	All
	S1	51.7	58.9	All
	S2	58.9	67.2	All
	T1	67.2	76.6	[¹]
Green	T2	76.6	87.4	[¹]
	U1	87.4	99.6	All
	U2	99.6	113.6	All
	V1	113.6	129.5	All
Cyan	V2	129.5	147.7	[¹]
	S2	58.9	67.2	All
	T1	67.2	76.6	All
	T2	76.6	87.4	All
Blue	U1	87.4	99.6	[¹]
	N	18.1	23.5	A,1 [¹]
	P	23.5	30.6	A,1 [¹]
	Q	30.6	39.8	[¹]

- ProLight maintains a tolerance of $\pm 10\%$ on flux and power measurements.
- The flux bin of the product may be modified for improvement without notice.
- [¹] The rest of color bins are not 100% ready for order currently. Please ask for quote and order possibility.

Color Bin

White and Warm White Binning Structure Graphical Representation

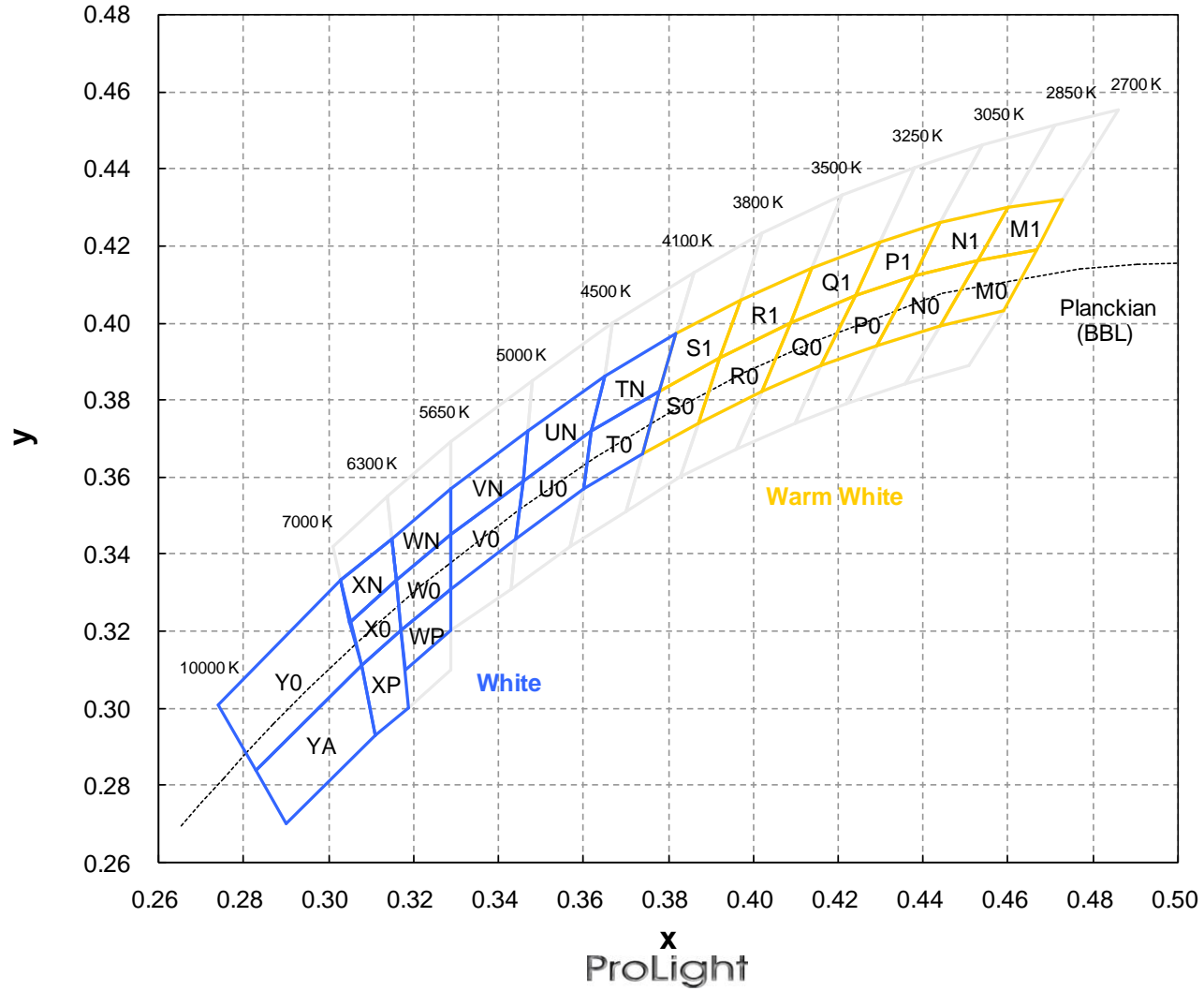

Color Bins

White Bin Structure

Bin Code	x	y	Typ. CCT (K)	Bin Code	x	y	Typ. CCT (K)
T0	0.378	0.382	4300	WN	0.329	0.345	5970
	0.374	0.366			0.316	0.333	
	0.360	0.357			0.315	0.344	
	0.362	0.372			0.329	0.357	
TN	0.382	0.397	4300	WP	0.329	0.331	5970
	0.378	0.382			0.329	0.320	
	0.362	0.372			0.318	0.310	
	0.365	0.386			0.317	0.320	
U0	0.362	0.372	4750	X0	0.308	0.311	6650
	0.360	0.357			0.305	0.322	
	0.344	0.344			0.316	0.333	
	0.346	0.359			0.317	0.320	
UN	0.365	0.386	4750	XN	0.305	0.322	6650
	0.362	0.372			0.303	0.333	
	0.346	0.359			0.315	0.344	
	0.347	0.372			0.316	0.333	
V0	0.329	0.331	5320	XP	0.308	0.311	6650
	0.329	0.345			0.317	0.320	
	0.346	0.359			0.319	0.300	
	0.344	0.344			0.311	0.293	
VN	0.329	0.345	5320	Y0	0.308	0.311	8000
	0.329	0.357			0.283	0.284	
	0.347	0.372			0.274	0.301	
	0.346	0.359			0.303	0.333	
W0	0.329	0.345	5970	YA	0.308	0.311	8000
	0.329	0.331			0.311	0.293	
	0.317	0.320			0.290	0.270	
	0.316	0.333			0.283	0.284	

- Tolerance on each color bin (x , y) is ± 0.01

Note: Although several bins are outlined, product availability in a particular bin varies by production run and by product performance. Not all bins are available in all colors.

Color Bins



Warm White Bin Structure

Bin Code	x	y	Typ. CCT (K)	Bin Code	x	y	Typ. CCT (K)
M0	0.453	0.416	2770	Q0	0.409	0.400	3370
	0.444	0.399			0.402	0.382	
	0.459	0.403			0.416	0.389	
	0.467	0.419			0.424	0.407	
M1	0.460	0.430	2770	Q1	0.414	0.414	3370
	0.453	0.416			0.409	0.400	
	0.467	0.419			0.424	0.407	
	0.473	0.432			0.430	0.421	
N0	0.438	0.412	2950	R0	0.392	0.391	3650
	0.429	0.394			0.387	0.374	
	0.444	0.399			0.402	0.382	
	0.453	0.416			0.409	0.400	
N1	0.444	0.426	2950	R1	0.414	0.414	3650
	0.438	0.412			0.409	0.400	
	0.453	0.416			0.392	0.391	
	0.460	0.430			0.397	0.406	
P0	0.424	0.407	3150	S0	0.392	0.391	3950
	0.416	0.389			0.387	0.374	
	0.429	0.394			0.374	0.366	
	0.438	0.412			0.378	0.382	
P1	0.430	0.421	3150	S1	0.397	0.406	3950
	0.424	0.407			0.392	0.391	
	0.438	0.412			0.378	0.382	
	0.444	0.426			0.382	0.397	

- Tolerance on each color bin (x , y) is ± 0.01

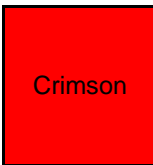

Note: Although several bins are outlined, product availability in a particular bin varies by production run and by product performance. Not all bins are available in all colors.

Peak Wavelength Bin Structure

Color	Bin Code	Minimum Peak Wavelength (nm)	Maximum Peak Wavelength (nm)
	1	650	655
	2	655	660
	3	660	665
	4	665	670
	1	720	740

- ProLight maintains a tolerance of ± 1 nm for peak wavelength

Dominant Wavelength Bin Structure

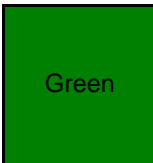
Color	Bin Code	Minimum Dominant Wavelength (nm)	Maximum Dominant Wavelength (nm)
	2	613.5	620.5
	4	620.5	631.0
	2	587.0	589.5
	4	589.5	592.0
	6	592.0	594.5
	7	594.5	597.0
	A	515	520
	1	520	525
	2	525	530
	3	530	535
	A	495	500
	1	500	505
	2	505	510
	3	510	515
	A	455	460
	1	460	465
	2	465	470
	3	470	475
	5	450	455
	6	455	460

- ProLight maintains a tolerance of ± 1 nm for dominant wavelength measurements.

Note: Although several bins are outlined, product availability in a particular bin varies by production run and by product performance. Not all bins are available in all colors.

Forward Voltage Bin Structure

Color	Bin Code	Minimum Voltage (V)	Maximum Voltage (V)
White	A	2.85	3.10
	B	3.10	3.35
	D	3.35	3.60
	E	3.60	3.85
Warm White	A	2.85	3.10
	B	3.10	3.35
	D	3.35	3.60
	E	3.60	3.85
Red	A	1.75	2.00
	B	2.00	2.25
	D	2.25	2.50
	E	2.50	2.75
	F	2.75	3.00
Amber	A	1.75	2.00
	B	2.00	2.25
	D	2.25	2.50
	E	2.50	2.75
	F	2.75	3.00
Green	A	2.85	3.10
	B	3.10	3.35
	D	3.35	3.60
	E	3.60	3.85
Cyan	A	2.85	3.10
	B	3.10	3.35
	D	3.35	3.60
	E	3.60	3.85
Blue	A	2.85	3.10
	B	3.10	3.35
	D	3.35	3.60
	E	3.60	3.85
Royal Blue	A	2.85	3.10
	B	3.10	3.35
	D	3.35	3.60
	E	3.60	3.85
Crimson	A	1.75	2.00
	B	2.00	2.25
	D	2.25	2.50
	E	2.50	2.75
	F	2.75	3.00
Cherry Red	a	1.50	1.75
	A	1.75	2.00
	B	2.00	2.25
	D	2.25	2.50
	E	2.50	2.75

- ProLight maintains a tolerance of $\pm 0.1V$ for Voltage measurements.

Note: Although several bins are outlined, product availability in a particular bin varies by production run and by product performance. Not all bins are available in all colors.

Color Spectrum, $T_J = 25^\circ\text{C}$

1. White

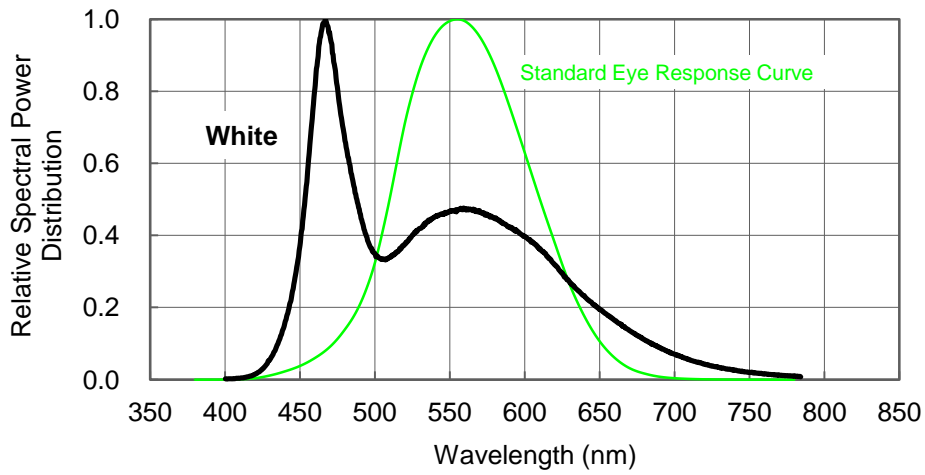

2. Warm White

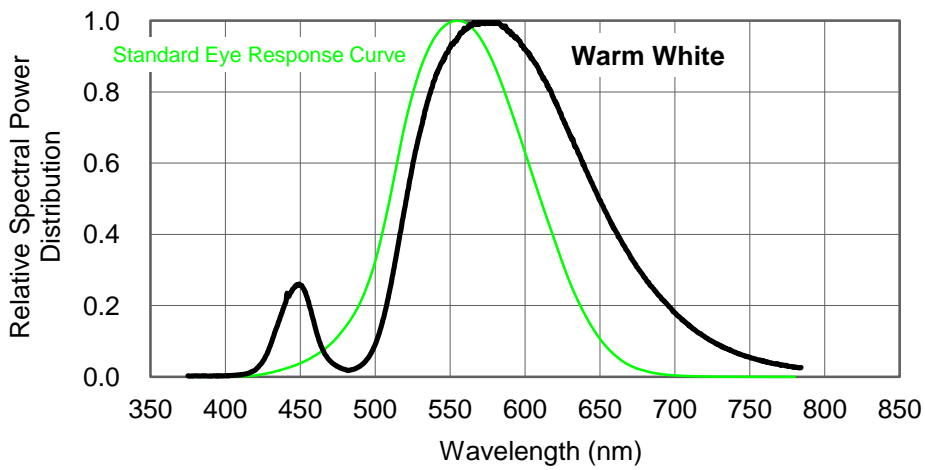

3. Royal Blue 、 Blue 、 Cyan 、 Green 、 Amber 、 Red 、 Crimson 、 Cherry Red

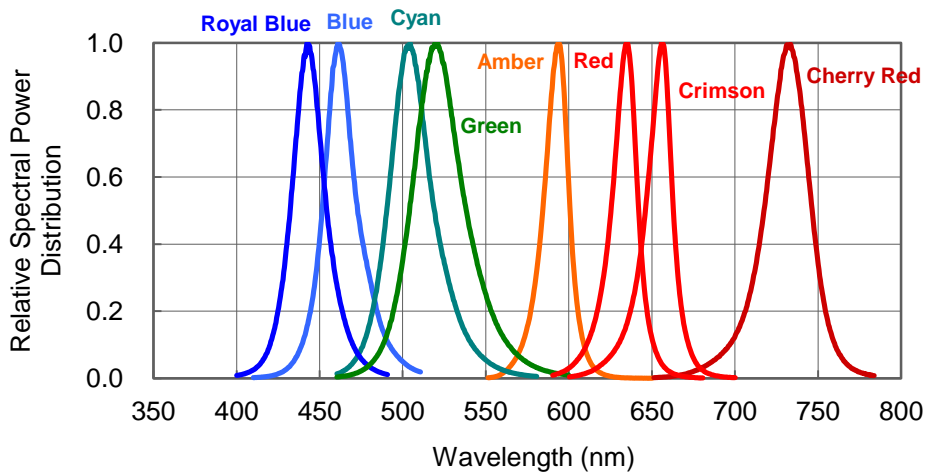

ProLight

Light Output Characteristics

Relative Light Output vs. Junction Temperature at 350mA

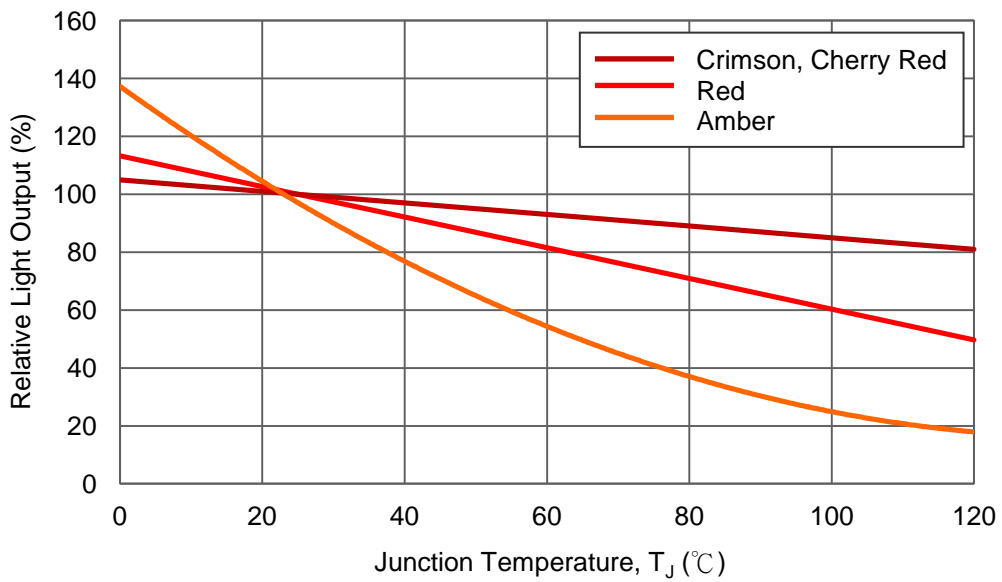
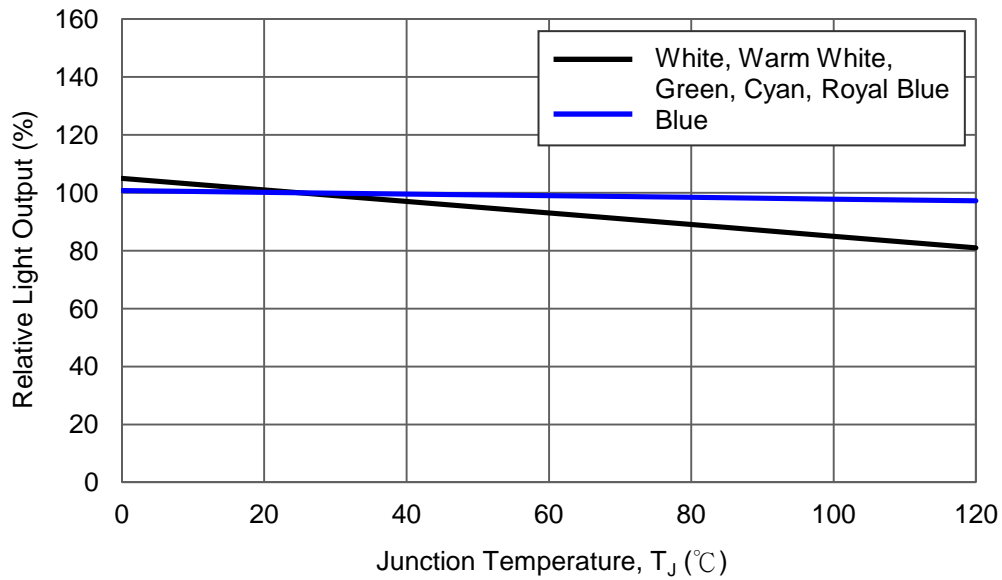

Forward Current Characteristics, $T_J = 25^\circ\text{C}$

1. Forward Voltage vs. Forward Current

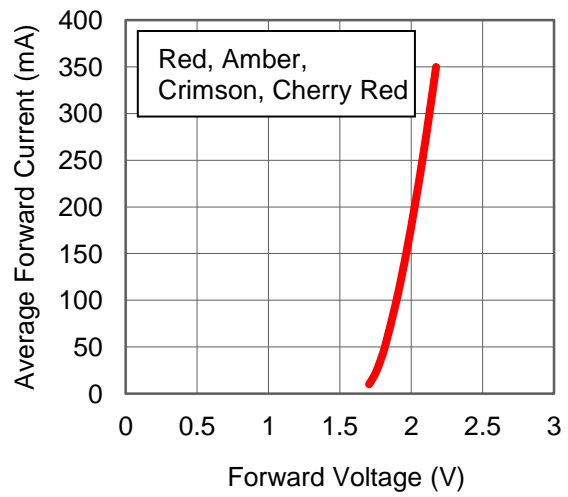
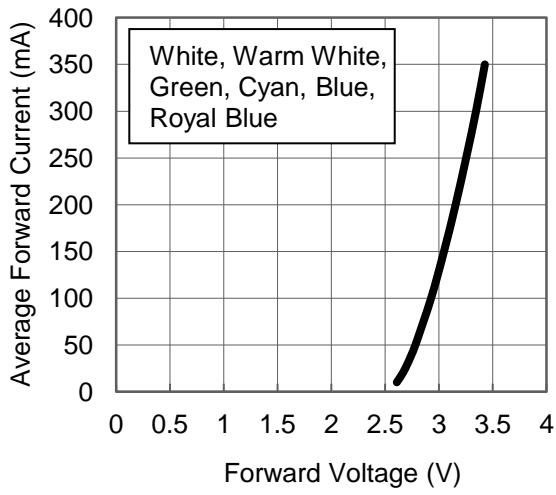

2. Forward Current vs. Normalized Relative Luminous Flux

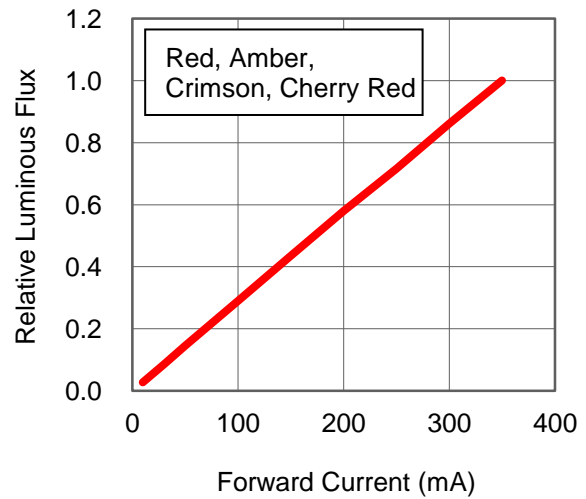
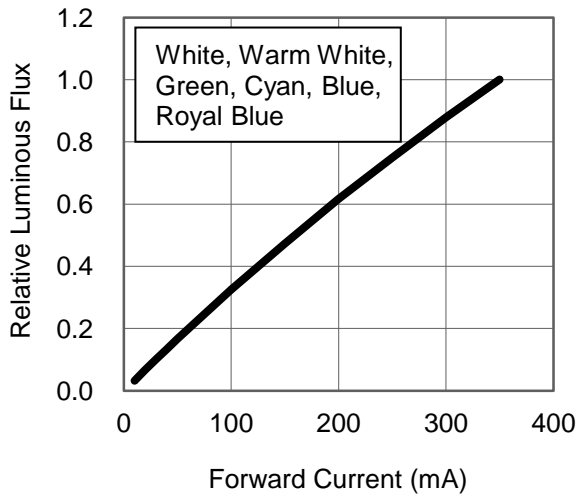

Ambient Temperature vs. Maximum Forward Current

1. White, Warm White, Green, Cyan, Blue, Royal Blue ($T_{JMAX} = 120^{\circ}C$)

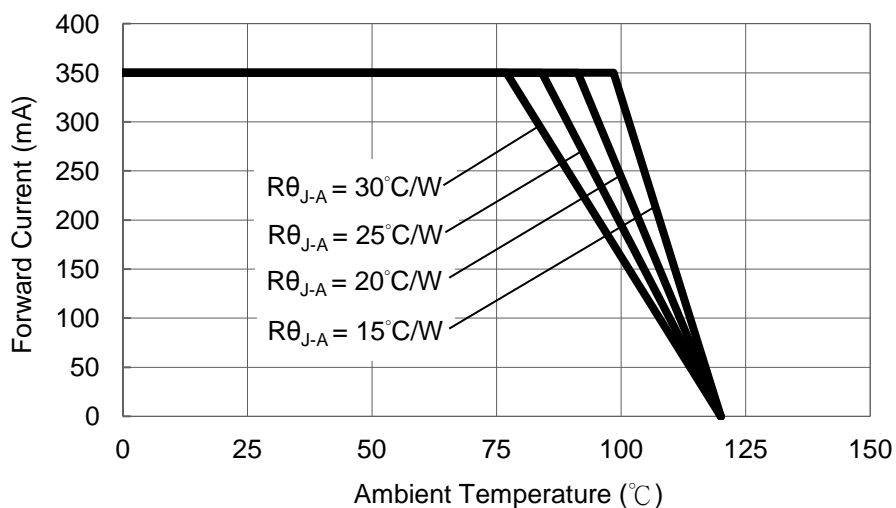

2. Red, Amber, Crimson, Cherry Red ($T_{JMAX} = 120^{\circ}C$)

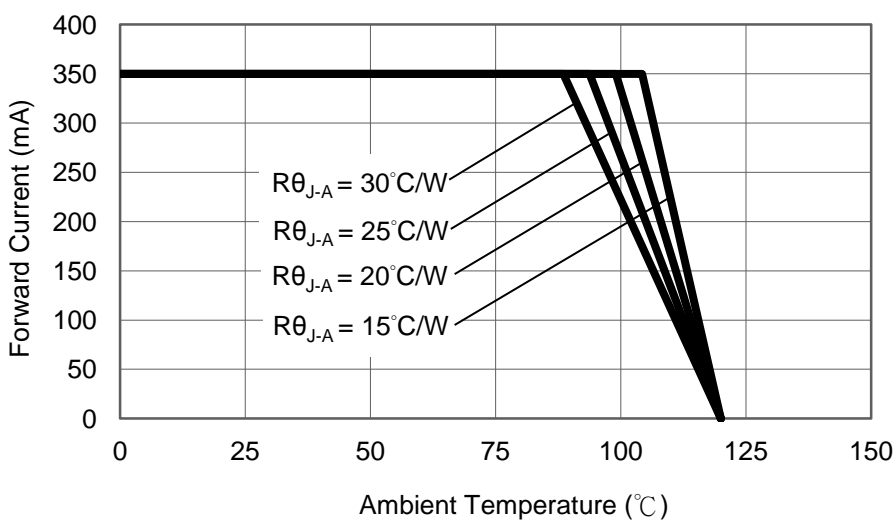

Typical Representative Spatial Radiation Pattern

Lambertian Radiation Pattern

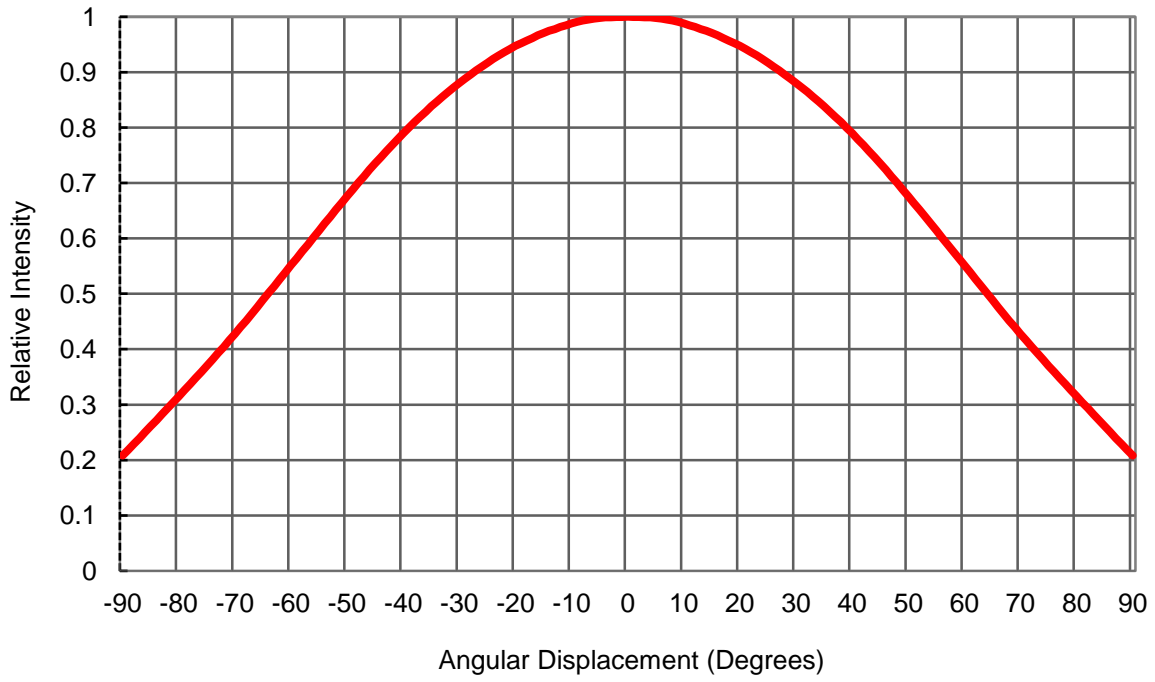

Moisture Sensitivity Level - JEDEC Level 1

Level	Floor Life		Soak Requirements			
			Standard		Accelerated Environment	
	Time	Conditions	Time (hours)	Conditions	Time (hours)	Conditions
1	Unlimited	≤30°C / 85% RH	168 +5/-0	85°C / 85% RH	NA	NA

- The standard soak time includes a default value of 24 hours for semiconductor manufacture's exposure time (MET) between bake and bag and includes the maximum time allowed out of the bag at the distributor's facility.
- Table below presents the moisture sensitivity level definitions per IPC/JEDEC's J-STD-020C.

Level	Floor Life		Soak Requirements			
			Standard		Accelerated Environment	
	Time	Conditions	Time (hours)	Conditions	Time (hours)	Conditions
1	Unlimited	≤30°C / 85% RH	168 +5/-0	85°C / 85% RH	NA	NA
2	1 year	≤30°C / 60% RH	168 +5/-0	85°C / 60% RH	NA	NA
2a	4 weeks	≤30°C / 60% RH	696 +5/-0	30°C / 60% RH	120 +1/-0	60°C / 60% RH
3	168 hours	≤30°C / 60% RH	192 +5/-0	30°C / 60% RH	40 +1/-0	60°C / 60% RH
4	72 hours	≤30°C / 60% RH	96 +2/-0	30°C / 60% RH	20 +0.5/-0	60°C / 60% RH
5	48 hours	≤30°C / 60% RH	72 +2/-0	30°C / 60% RH	15 +0.5/-0	60°C / 60% RH
5a	24 hours	≤30°C / 60% RH	48 +2/-0	30°C / 60% RH	10 +0.5/-0	60°C / 60% RH
6	Time on Label (TOL)	≤30°C / 60% RH	Time on Label (TOL)	30°C / 60% RH	NA	NA

Qualification Reliability Testing

Stress Test	Stress Conditions	Stress Duration	Failure Criteria
Room Temperature Operating Life (RTOL)	25°C, $I_F = \text{max DC}$ (Note 1)	1000 hours	Note 2
Wet High Temperature Operating Life (WHTOL)	85°C/60%RH, $I_F = \text{max DC}$ (Note 1)	1000 hours	Note 2
Wet High Temperature Storage Life (WHTSL)	85°C/85%RH, non-operating	1000 hours	Note 2
High Temperature Storage Life (HTSL)	110°C, non-operating	1000 hours	Note 2
Low Temperature Storage Life (LTSL)	-40°C, non-operating	1000 hours	Note 2
Non-operating Temperature Cycle (TMCL)	-40°C to 120°C, 30 min. dwell, <5 min. transfer	200 cycles	Note 2
Non-operating Thermal Shock (TMSK)	-40°C to 120°C, 20 min. dwell, <20 sec. transfer	200 cycles	Note 2
Mechanical Shock	1500 G, 0.5 msec. pulse, 5 shocks each 6 axis		Note 3
Natural Drop	On concrete from 1.2 m, 3X		Note 3
Variable Vibration Frequency	10-2000-10 Hz, log or linear sweep rate, 20 G about 1 min., 1.5 mm, 3X/axis		Note 3
Solderability	Steam age for 16 hrs., then solder dip at 260°C for 5 sec.		Solder coverage on lead

Notes:

1. Depending on the maximum derating curve.
2. Criteria for judging failure

Item	Test Condition	Criteria for Judgement	
		Min.	Max.
Forward Voltage (V_F)	$I_F = \text{max DC}$	--	Initial Level x 1.1
Luminous Flux or Radiometric Power (Φ_V)	$I_F = \text{max DC}$	Initial Level x 0.7	--
Reverse Current (I_R)	$V_R = 5V$	--	50 μA

* The test is performed after the LED is cooled down to the room temperature.

3. A failure is an LED that is open or shorted.

Recommended Solder Pad Design

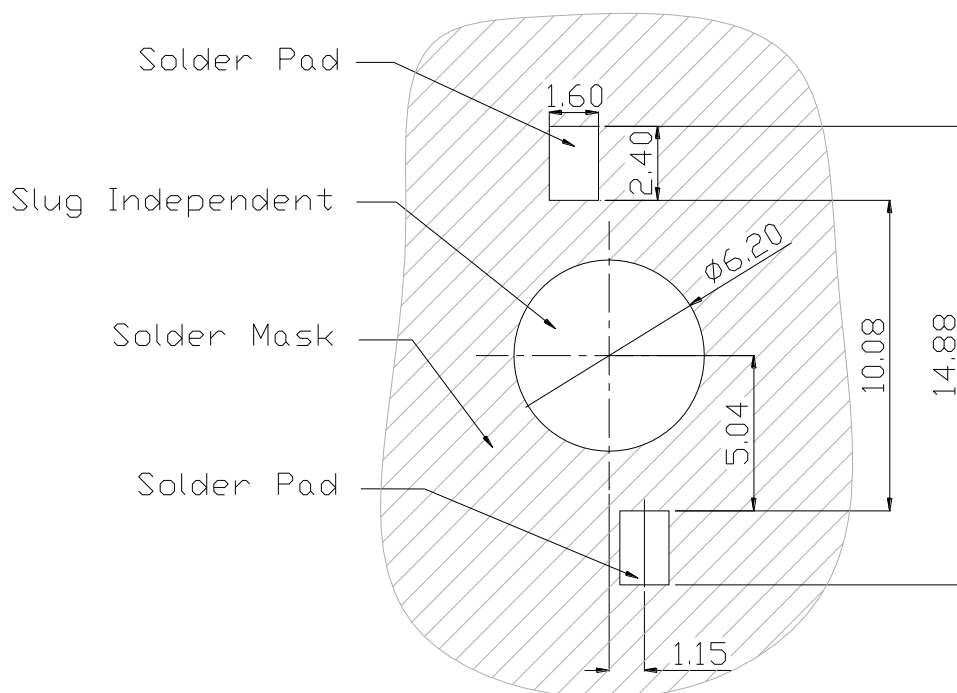

- All dimensions are in millimeters.
- Electrical isolation is required between Slug and Solder Pad.

Reflow Soldering Condition

Profile Feature	Sn-Pb Eutectic Assembly	Pb-Free Assembly
Average Ramp-Up Rate (T_{Smax} to T_P)	3°C / second max.	3°C / second max.
Preheat – Temperature Min (T_{Smin}) – Temperature Max (T_{Smax}) – Time (t_{Smin} to t_{Smax})	100°C 150°C 60-120 seconds	150°C 200°C 60-180 seconds
Time maintained above: – Temperature (T_L) – Time (t_L)	183°C 60-150 seconds	217°C 60-150 seconds
Peak/Classification Temperature (T_P)	240°C	260°C
Time Within 5°C of Actual Peak Temperature (t_P)	10-30 seconds	20-40 seconds
Ramp-Down Rate	6°C/second max.	6°C/second max.
Time 25°C to Peak Temperature	6 minutes max.	8 minutes max.

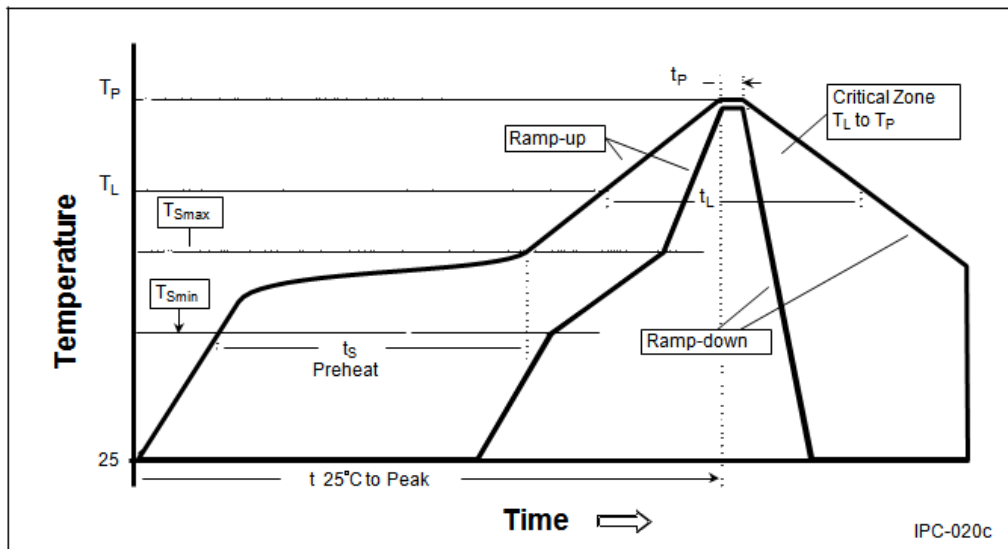

- **We recommend using the M705-S101-S4 solder paste from SMIC (Senju Metal Industry Co., Ltd.) for lead-free soldering.**
- All temperatures refer to topside of the package, measured on the package body surface.
- Repairing should not be done after the LEDs have been soldered. When repairing is unavoidable, a double-head soldering iron should be used. It should be confirmed beforehand whether the characteristics of the LEDs will or will not be damaged by repairing.
- Reflow soldering should not be done more than three times.
- When soldering, do not put stress on the LEDs during heating.
- After soldering, do not warp the circuit board.

Emitter Tube Packaging

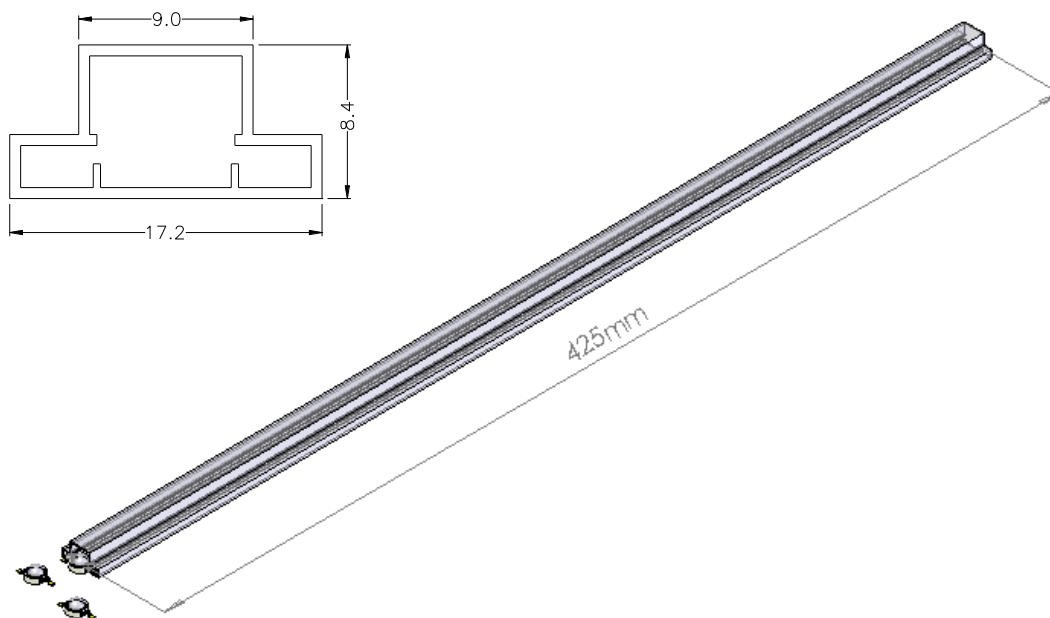

Notes:

1. 50 pieces per tube.
2. Drawing not to scale.
3. All dimensions are in millimeters.
4. All dimensions without tolerances are for reference only.

**Please do not open the moisture barrier bag (MBB) more than one week. This may cause the leads of LED discoloration. We recommend storing ProLight's LEDs in a dry box after opening the MBB. The recommended storage conditions are temperature 5 to 30°C and humidity less than 40% RH.

Precaution for Use

- Storage
Please do not open the moisture barrier bag (MBB) more than one week. This may cause the leads of LED discoloration. We recommend storing ProLight's LEDs in a dry box after opening the MBB. The recommended storage conditions are temperature 5 to 30°C and humidity less than 40% RH. It is also recommended to return the LEDs to the MBB and to reseal the MBB.
- The slug is not electrically neutral. Therefore, we recommend to isolate the heat sink.
- **We recommend using the M705-S101-S4 solder paste from SMIC (Senju Metal Industry Co., Ltd.) for lead-free soldering.**
- Any mechanical force or any excess vibration shall not be accepted to apply during cooling process to normal temperature after soldering.
- Please avoid rapid cooling after soldering.
- Components should not be mounted on warped direction of PCB.
- Repairing should not be done after the LEDs have been soldered. When repairing is unavoidable, a heat plate should be used. It should be confirmed beforehand whether the characteristics of the LEDs will or will not be damaged by repairing.
- This device should not be used in any type of fluid such as water, oil, organic solvent and etc. When cleaning is required, isopropyl alcohol should be used.
- When the LEDs are illuminating, operating current should be decided after considering the package maximum temperature.
- The appearance, specifications and flux bin of the product may be modified for improvement without notice. Please refer to the below website for the latest datasheets.
<http://www.prolightopto.com/>