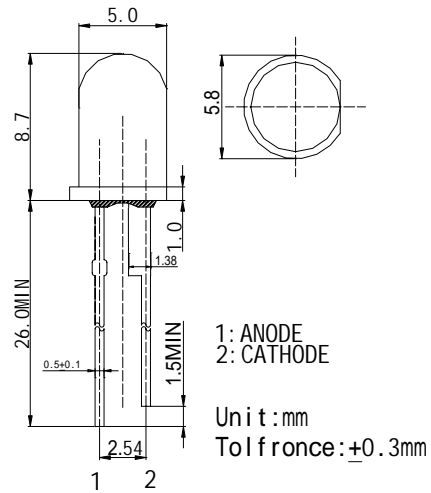

■Features

- Deluxe Power LEDs
- 5ø Standard Directivity
- Superior Weather-resistance
- UV Resistant Epoxy
- Water Clear Type

■Applications

- Automotive Dashboard Lighting
- Back Lighting

■Outline Dimension

■Absolute Maximum Rating

(Ta=25 °C)

Item	Symbol	Value	Unit
DC Forward Current	I_F	100	mA
Pulse Forward Current*	I_{FP}	150	mA
Reverse Voltage	V_R	5	V
Power Dissipation	P_D	500	mW
Operating Temperature	T_{opr}	-30 ~ +80	
Storage Temperature	T_{stg}	-30 ~ +100	
Lead Soldering Temperature	T_{sol}	260 /3sec	-

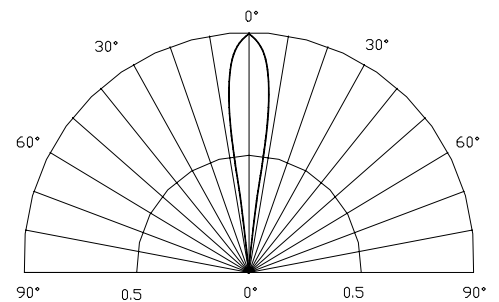
*Pulse width Max.10ms Duty ratio max 1/10

■Directivity

■Electrical -Optical Characteristics

(Ta=25 °C)

Item	Symbol	Condition	Min.	Typ.	Max.	Unit
DC Forward Voltage	V_F	$I_F=75mA$	3.0	3.6	4.2	V
DC Reverse Current	I_R	$V_R=5V$			10	μA
Luminous Intensity	I_v	$I_F=75mA$	30000	40000	50000	mcd
Chromaticity Coordinate*	x	$I_F=75mA$	0.19	0.25	0.29	
	y	$I_F=75mA$	0.21	0.25	0.28	
50% Power Angle	$2\theta_{1/2}$	$I_F=75mA$		15	-	deg