

Document Name	Document No.	Date	Page
LIR1655 Specification	ZJQM-RD-SPC-H0358	2019-4-19	1/9

EEMB BATTERY



Li-ion Battery

Specification

锂离子电池

产品规格书

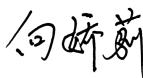
Model 型号:	LIR1655
Capacity 容量:	110mAh

Prepared 编制	Checked 审核	Approved 批准
		

Customer 客户名称:

Customer Approval (Customer confirmation) 客户确认:

Signature 签字	Checked 审核	Approved 批准

Address: 6 /F, Block 110, Jindi Industrial Zone, ShaTou Street, Futian District, ShenZhen,China

Postal code: 518048

Phone: +86-755-83022275

Fax: +86-755-83021966

<https://www.eemb.com>



Document Name	Document No.	Date	Page
LIR1655 Specification	ZJQM-RD-SPC-H0358	2019-4-19	2/9

Catalog

Chapter	Content	Page
0	Catalog.....	2
1	Scope.....	3
2	Battery Basic Characteristics.....	3
3	Battery Shape and Dimension.....	3
4	Appearance.....	3
5	Battery Characteristics.....	4-5
6	Characteristics Curves.....	5-6
7	Warranty.....	7
8	Matters Needing Attention.....	7-9

Document Name	Document No.	Date	Page
LIR1655 Specification	ZJQM-RD-SPC-H0358	2019-4-19	3/9

1. Scope 适用范围

This product specification defines the requirements of the rechargeable lithium-ion button battery supplied to the customer by EEMB Co., Ltd.

本产品规格书适用于 EEMB 提供的锂离子扣式电池。

2. Battery Basic Characteristics 电池产品基本特性

No.	Item 项目	Characteristics 性能指标	Remark 备注
2.1	Model 型号	LIR1655	
2.2	Capacity 容量	Nominal 标称容量	110 mAh
		Minimum 最小容量	100 mAh
2.3	Nominal Voltage 额定电压	3.7 V	
2.4	Dimension 尺寸	Diameter 直径	16.0 (Max) mm
		Height 高度	5.5±0.5 mm
2.5	Weight 重量	3.35 g	
2.6	Working Temperature 工作温度	-20 ~ +60 °C	
2.7	Storage Temperature 贮存温度	20±1 °C	

3. Battery Shape and Dimension (Unit: mm)

电池产品外形及尺寸 (单位: mm)

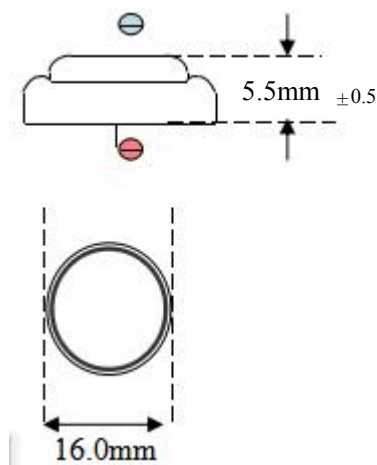

Item 项目	Specification 规格
Diameter 直径	16.0 (Max)
Height 高度	5.5±0.5

4. Appearance 外观

It shall be free from any defects such as remarkable scratches, breaks, cracks, discoloration, leakage, or middle deformation.

电池表面无划伤、裂纹、脏点、锈蚀、变形、变色、漏液等缺陷，中间无翘起。

5. Battery Characteristics 电池性能

5.1 Charge and Discharge Characteristics 电池充放电性能

No.	Item 项目	Test Instructions 测试方法
5.1.1	Standard Charge/Discharge 标准充/放电	In a temperature of 25°C, CC charge 0.2CmA / voltage up to 4.20V. Then CV charge. Terminate charging when the charging current value is less than 0.05CmA. Rest for no more than 10 minutes, discharge CC at 0.2CmA to 2.75V. 在环境温度 25°C 的条件下, 以 0.2CmA 恒流充电, 当电池端电压达到充电限制电压 4.20V 后, 转为恒压充电, 当电流值小于 0.05CmA 时终止充电并放置不超过 10 分钟, 再以 0.2CmA 电流恒流放电到 2.75V。
5.1.2	Fast Charge/Discharge 快速充/放电	Temperature 25°C, CC charge at 1.0CmA to 4.20V, turn to CV charge. Terminate charging when the charging current value is less than 0.05CmA, rest for no more than 10 minutes, then at 1CmA CC discharge to 2.75V. 在环境温度 25°C 的条件下, 以 1CmA 恒流充电, 当电池端电压达到充电限制电压 4.20V 时, 转为恒压充电, 当电流值小于 0.05CmA 时终止充电并放置不超过 10 分钟, 再以 1CmA 电流恒流放电到 2.75V。

Note: Unless otherwise specified, all tests stated in this specification are conducted at the following conditions: Temp.: 25°C, Relative Humidity: 75±5%, Atmosphere Pressure: 1atm.

备注: 除特别说明外, 本产品规格书规定的测试条件为: 温度 25°C, 相对湿度 75±5%, 大气压力 1atm。

5.2 General Features 主要特点

No.	Item 项目	Criteria 标准
5.2.1	Long Cycle Life 使用寿命长	Under normal usage, the cycle life of the battery can be ≥ 300 circles while with capacity $\geq 80\%$ 在标准充放电条件下, 可循环使用充放电周期 ≥ 300 周, 容量 $\geq 80\%$ 。
5.2.2	High Power Density 高能量密度	High power density makes the battery light in weight and small in dimension. It can be used in small devices. 高能量密度, 使电池重量轻、体积小, 方便使用于小型用电设备。
5.2.3	Safe and Reliable 使用安全可靠	No floating metal lithium assures a safer usage. 没有游离的金属锂, 电池使用更安全。
5.2.4	High working voltage 工作电压高	Working voltage is up to 3.7V, approx. 3 times of the voltage of NI-MH or NI-CD, which reduces the quantity of the battery needed in certain application. 工作电压高达 3.7V, 大约是镍镉或镍氢电池的 3 倍, 可减少电池的使用数量。
5.2.5	No memory effect 无记忆效应	No memory effect assures a constant maximum application. 无记忆效应, 使其无时不为你提供最大的能量。
5.2.6	Low self-discharge rate 自放电率小	$\leq 3\%$ /month. $\leq 3\%$ /月。

Document Name	Document No.	Date	Page
LIR1655 Specification	ZJQM-RD-SPC-H0358	2019-4-19	5/9

5.2.7	Good Consistency 一致性好	<p>Good consistency is showed in battery capacity, internal resistance, discharge platform and capacity retention. Establish a quality assurance system in accordance with ISO9000 standards, and strictly control the entire production process.</p> <p>按 ISO9000 标准建立质量保证体系, 对生产全过程实行严格控制, 使电池容量、内阻、放电平台、荷电保持能力等性能保持良好的一致性。</p>
-------	--------------------------	---

6. Characteristics Curves 性能曲线图

6.1 Charging Characteristics at Various Currents 不同电流条件下的充电特性

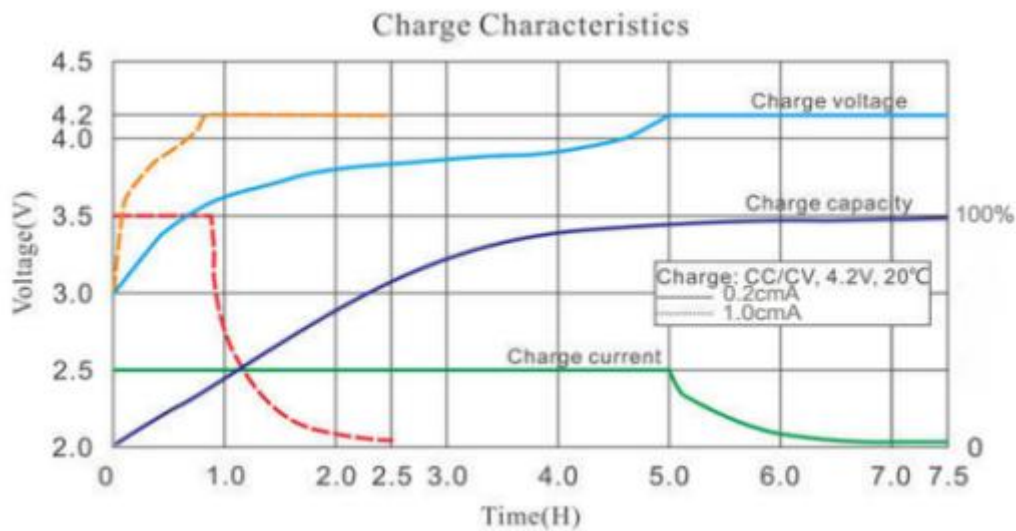

6.2 Discharge Characteristics at Various Currents 不同电流条件下的放电特性

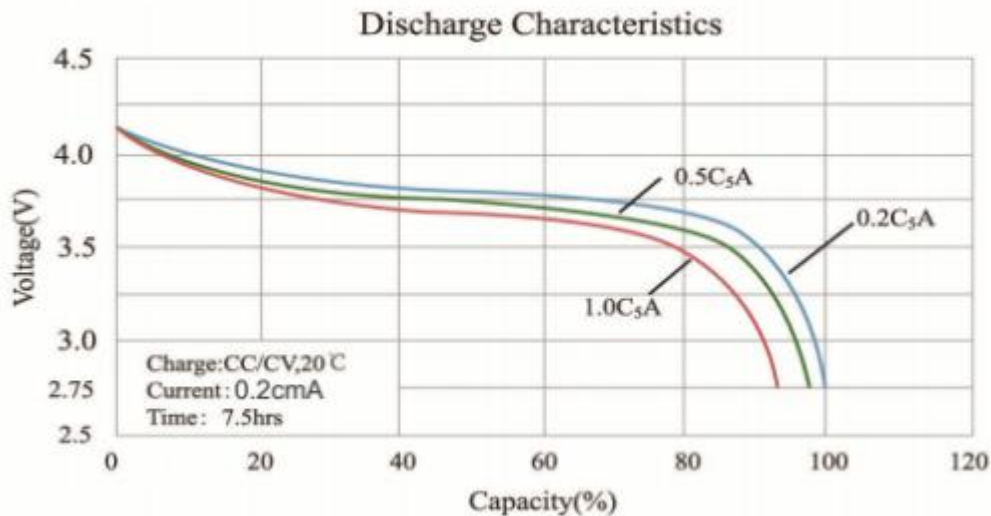

Document Name	Document No.	Date	Page
LIR1655 Specification	ZJQM-RD-SPC-H0358	2019-4-19	6/9

6.3 Discharging Characteristics at Various Temperatures 不同温度条件下的放电特性

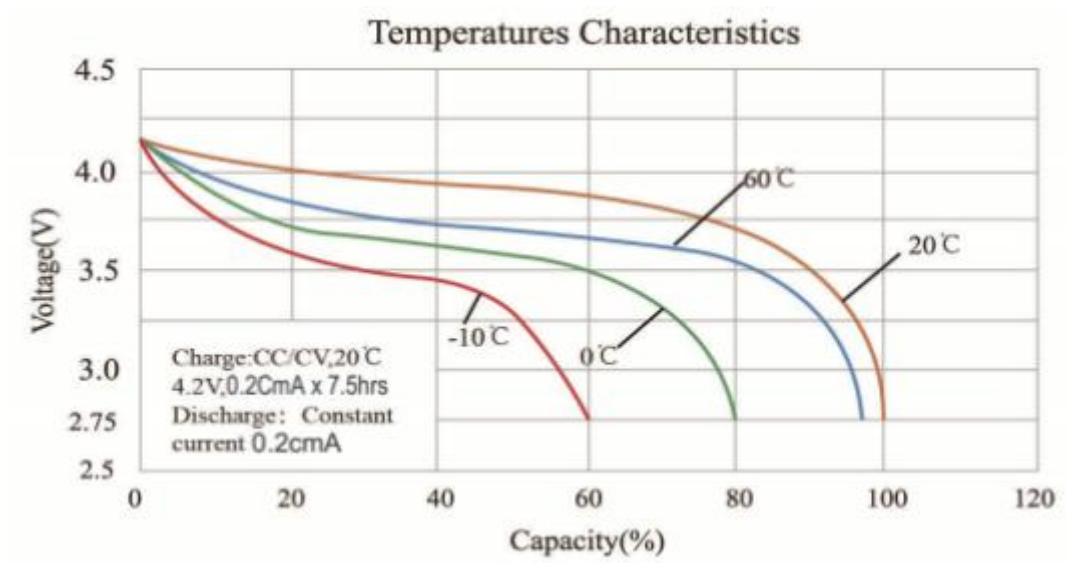

6.4 Storage Characteristics 自放电特性

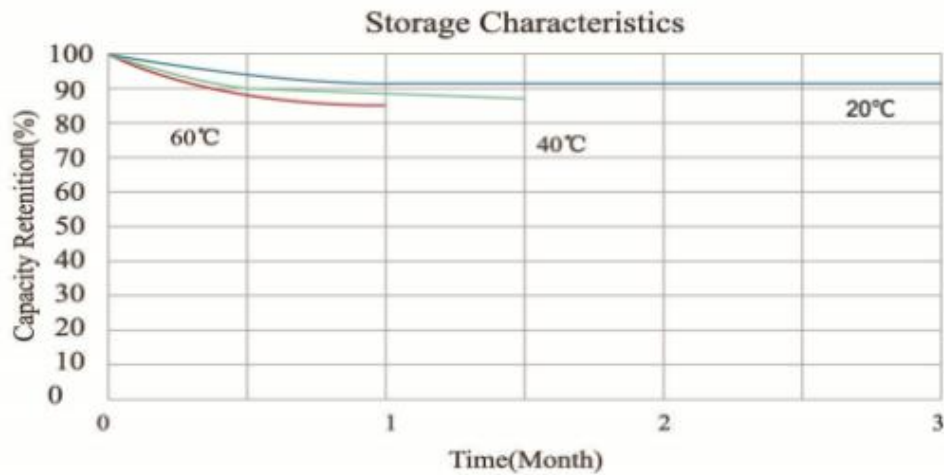

6.5 Cycle Life 循环寿命曲线

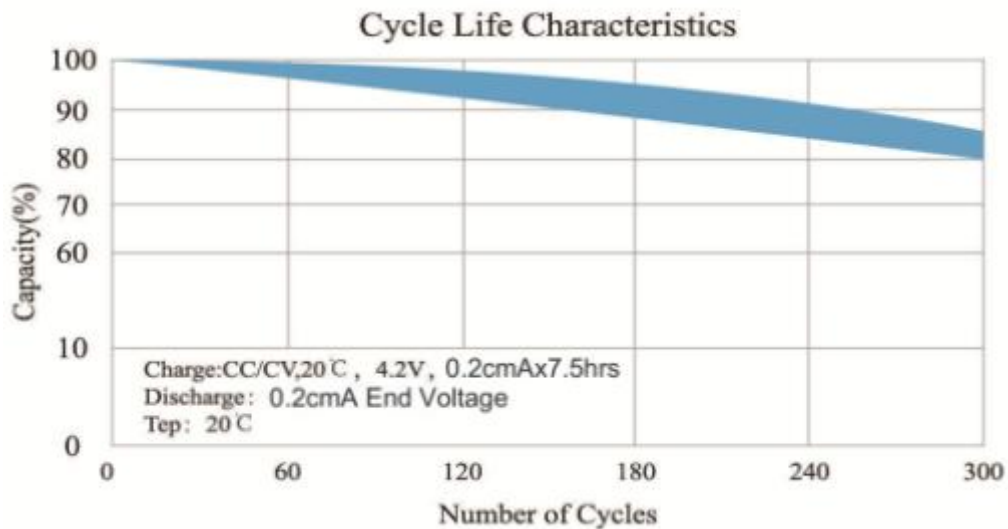

Document Name	Document No.	Date	Page
LIR1655 Specification	ZJQM-RD-SPC-H0358	2019-4-19	7/9

7. Warranty 保质期

6 months warranty for sample battery after date of production. One year warranty for finished battery after the date of production.

样品电池保质期为（出厂之日起）半年；产品电池保质期为（出厂之日起）1年。

8. Matters Needing Attention 注意事项

Strictly observes the following needing attention. EEMB will not be responsible for any accident occurred by handling outside of the precautions in this specification.

您必须严格遵守下述电池使用注意事项。对于没有按照以下注意事项所造成的任何意外事故，EEMB 不承担任何责任。

! Danger 危险

- Strictly prohibits heat or throw cell into fire. 严禁把将电池投进火中或进行加热
- Strictly prohibits throw and wet cell in liquid such as water、gasoline or drink etc.
严禁把电池投入液体中，如水、汽油、饮料等，也不要把电池弄湿。
- Strictly prohibits use leave cell close to fire or inside of a car where temperature may be above 60°C .
Also do not charge / discharge in such conditions.
禁止在火源附近或温度超过 60°C 的轿车中使用或遗留电池，也不要这些环境中进行充放电。
- Strictly prohibits put batteries in your pockets or a bag together with metal objects such as necklaces. Hairpins, coins, or screws. Do not store or transportation batteries with such objects.
禁止把电池同项链、发夹、硬币或螺钉等金属品一起放在兜中或包中，也不要把电池同上述物品一起储存或运输。
- Strictly prohibits short circuit by any way.
禁止任何形式对电池短路。
- Do not place Cell in a device with the (+) and (-) in the wrong way around.
在装入设备时注意电池的正负极不要反装。
- Strictly prohibits pierce Cell with a sharp object such as a needle.
禁止使用锐利的物品刺穿电池。
- Strictly prohibits disassemble or modify the cell.
禁止对电池进行分解。
- Strictly prohibits welding a cell directly.
禁止直接对电池进行焊接。
- Do not use a Cell with serious scar or deformation.
禁止使用已经损坏的电池。
- Thoroughly read the user's manual before use, inaccurate handling of lithium-ion rechargeable cell may cause leakage, heat, smoke, an explosion, or fire, capacity decreasing.
在使用之前请详细阅读操作说明书，不适当的操作可能引起电池变热、着火、爆炸、毁坏或电池容量的衰减。

Document Name	Document No.	Date	Page
LIR1655 Specification	ZJQM-RD-SPC-H0358	2019-4-19	8/9

! Warning 警告

- Strictly prohibits put cell into a microwave oven, dryer, or high-pressure container.
禁止把电池放加热器皿、洗衣机或高压容器中。
- Strictly prohibits use cell with dry cells and other primary batteries, or new and old battery or batteries of a different package, type, or brand.
禁止把电池同干电池或其它原电池或者新旧电池一起使用，也不要同不同包装、不同型号或不同品牌的电池一起使用。
- Stop charging the Cell if charging is not completed within the specified time.
如果在规定的充电时间内充电没有结束，停止充电。
- Stop using the Cell if abnormal heat, odor, discoloration, deformation or abnormal condition is detected during use, charge, or storage.
在使用、充电或储存期间如发现电池有变热、散发气味、变色、变形或其它反常之处停止使用。
- Keep away from fire immediately when leakage or foul odor is detected.
当发现电池漏液或散发出难闻的气味时立即远离。
- If liquid leaks onto your skin or clothes, wash well with fresh water immediately.
如果电解液渗漏到您的皮肤或衣服上，立刻用大量清水冲洗。
- If liquid leaking from the Cell gets into your eyes, do not rub your eyes. Wash them well with clean flowing water and go to see a doctor immediately.
如果电解液渗出并进入您的眼睛里，不要揉擦您的眼睛，立刻用大量清水清洗眼睛并就医。

! Caution 注意

- Before using the Cell, be sure to read the user's manual and cautions on handling thoroughly.
在使用电池之前，应仔细阅读操作指南并对使用中的注意事项有足够深刻的理解。
- Charging with specific charger according to product specification. Charge with CC/CV method. Strictly prohibits reversed charging. Connect cell reverse will not charge the cell. At the same time, it will reduce the charge-discharge characteristics and safety characteristics; this will lead to product heat and leakage.
充电时请使用指定的充电器并按照本规格书的要求进行充电。采用恒流恒压方式充电，禁止反向充电。若电池正负极接反，将无法对电芯进行充电；同时，反向充电会降低电芯的充放电性能和安全性，并会导致发热和泄漏。
- Store batteries out of reach of children so that they are not accidentally swallowed.
把电池放到小孩够不到的地方以免吞服。
- If younger children use the Cell, their guardians should explain the proper handling.
小孩使用电池时，监护人应详细解释操作方法。
- Before using the Cell, be sure to read the user's manual and cautions on handling thoroughly.
在将电池装入设备或从设备中取出之前仔细阅读设备操作手册。
- Batteries have life cycles. If the time that the Cell powers equipment becomes much shorter than usual, the Cell life is at an end. Replace the Cell with a new same one.
电池具有使用寿命，如果使用电池的设备的工作时间比平常少的多，请更换新电池。
- When not using Cell for an extended period, remove it from the equipment and store in a place with low humidity and low temperature.
当长期不用时，要将电池从设备中取出并放在低温低湿的环境中保存。
- While the Cell pack is charged, used and stored, keep it away from objects or materials with static electric charges.

Document Name	Document No.	Date	Page
LIR1655 Specification	ZJQM-RD-SPC-H0358	2019-4-19	9/9

电池应在远离静电的场所进行充电、使用和储存。

- If the terminals of the Cell become dirty, wipe with a dry clothe before using the Cell.
如果电池的接线端变脏，在使用之前用干布擦净。
- Storage the cells in storage temperature range as the specifications. After full discharged, we suggest that charging to 3.6~4.0V if not used for a long time.
电芯应贮存在产品规格书规定的温度范围内，电芯放电放完后，如果长期不使用，建议充电至 3.6~4.0V 贮存。
- Battery should be charged and discharged every 3 months at 0.2 C during long term storage, and then charge to 50-70% of the capacity for storage.
- 电池在长期贮存过程中，必须每 3 个月 0.2C 进行充放电一次，然后充电至 50~70% 的容量进行贮存。
- Do not exceed these ranges of the following temperature ranges:
电池在使用和贮存时的温度不能超出下面的要求：

Working temperature range 工作温度范围: $-20^{\circ}\text{C} \sim 60^{\circ}\text{C}$

Storage temperature range 贮存温度范围: $20^{\circ}\text{C} \pm 1^{\circ}\text{C}$

! Special Notice 特别注意

Keep the cells in **50% charged state** during long period storage. We recommend to charge the battery up to 50% of the total capacity every 3 months after receipt of the battery and maintain the voltage 3.6~4.0V. And store the battery in cool and dry place.

电池在长时间储存的过程中保持带电量为 50%。我们建议每 3 个月充电至 50% 以上容量，保持电压在 3.6~4.0V。将电池存储在阴凉干燥的地方。

EEMB reserves the final explanation. Please use battery strictly according to specification. EEMB will not be responsible for any inappropriate operation. EEMB keeps the right to change product specifications without previous notice. If any question, please consult with the manufacturer

EEMB 保留最终解释权。请严格按照规范使用电池。EEMB 对任何不当操作将不负责。EEMB 保留修改产品规格书不另行通知的权利。如有任何问题，请咨询制造商。