



KBPC25005W THRU KBPC2510W

Reverse Voltage - 50 to 1000 Volts Forward Current -25.0 Amperes

SILICON BRIDGE RECTIFIERS

Features

- ◆ The plastic package carries Underwriters Laboratory Flammability Classification 94V-0
- ◆ Ideal for printed circuit boards
- ◆ Low reverse leakage
- ◆ High forward surge current capability
- ◆ High temperature soldering guaranteed: 260°C/10 seconds, 5 lbs. (2.3kg) tension

Mechanical Data

Case : JEDEC KBPC-25W Molded plastic body
Terminals : Solder plated, solderable per MIL-STD-750, Method 2026
Polarity : Polarity symbol marking on body
Mounting Position : Any
Weight : 0.93 ounce, 26.4 grams

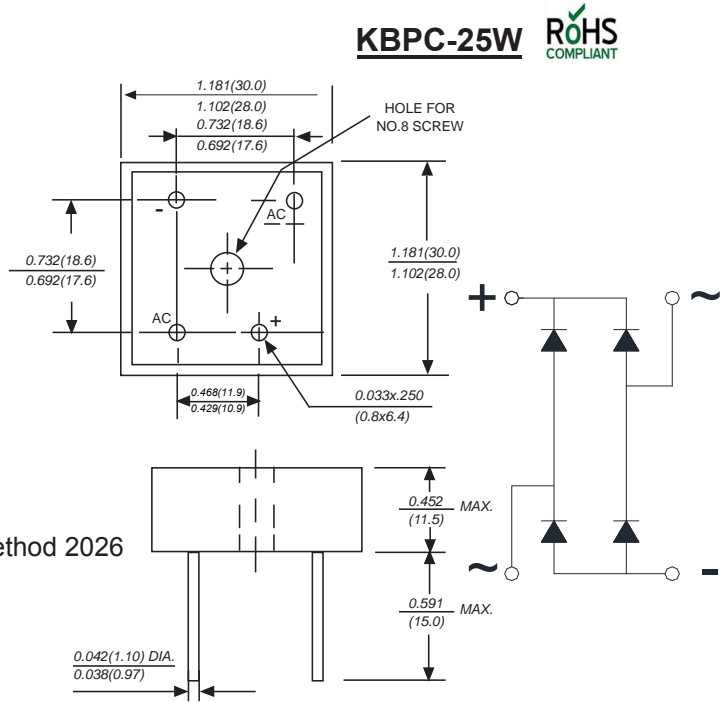

Dimensions in inches and (millimeters)

Maximum Ratings And Electrical Characteristics

Ratings at 25°C ambient temperature unless otherwise specified.

Single phase half-wave 60Hz, resistive or inductive load, for capacitive load current derate by 20%.

Parameter	SYMBOLS	MDD	MDD	MDD	MDD	MDD	MDD	MDD	UNITS
		KBPC25005W	KBPC2501W	KBPC2502W	KBPC2504W	KBPC2506W	KBPC2508W	KBPC2510W	
Marking Code									
Maximum repetitive peak reverse voltage	V _{RRM}	50	100	200	400	600	800	1000	V
Maximum RMS voltage	V _{RMS}	30	70	140	280	420	560	700	V
Maximum DC blocking voltage	V _{DC}	50	100	200	400	600	800	1000	V
Maximum average forward output rectified current at T _c =55°C (Note 1)	I _(AV)	25.0							A
Peak forward surge current 8.3ms single half sine-wave superimposed on rated load (JEDEC Method)	I _{FSM}	300							A
Rating for Fusing (t<8.3ms)	I ² _t	373							A ² s
Maximum instantaneous forward voltage drop per bridge element at 12.5A	V _F	1.1							V
Maximum DC reverse current at rated DC blocking voltage T _A =25°C T _A =100°C	I _R	10 1.0							μA mA
Isolation voltage from case to leads	V _{IOS}	2500							V _{AC}
Typical Thermal Resistance (Note 2)	R _{θJA}	2.0							°C/W
Operating junction temperature range	T _J	-65 to +150							°C
storage temperature range	T _{STG}	-65 to +150							°C

NOTES:

1. Unit mounted on 5" x 6" x 4.9" thick (12.8cm x 15.2cm x 12.4cm) Al. plate.
2. Bolt down on heat-sink with silicone thermal compound between bridge and mounting surface for maximum heat transfer efficiency with #8 screw.



KBPC25005W THRU KBPC2510W

Reverse Voltage - 50 to 1000 Volts Forward Current -25.0 Amperes

Ratings And Characteristic Curves

AVERAGE FORWARD RECTIFIED CURRENT, AMPERES

FIG. 1- FORWARD CURRENT DERATING CURVE

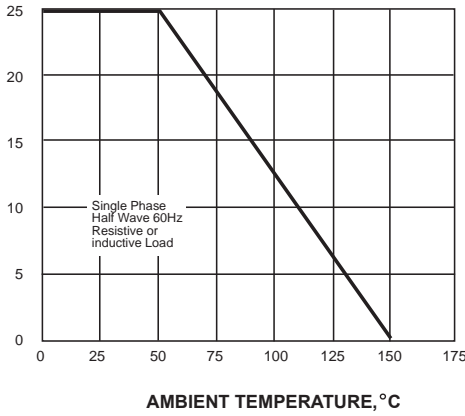

PEAK FORWARD SURGE CURRENT, AMPERES

FIG. 2-MAXIMUM NON-REPETITIVE PEAK FORWARD SURGE CURRENT

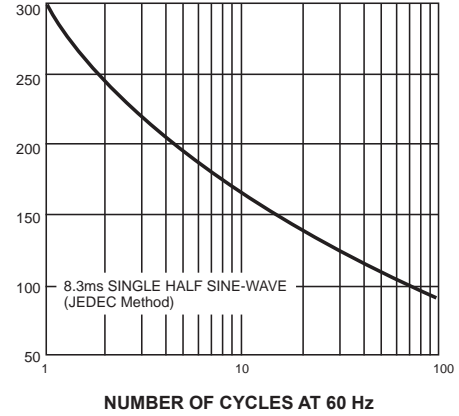

INSTANTANEOUS FORWARD CURRENT, AMPERES

FIG. 3-TYPICAL INSTANTANEOUS FORWARD CHARACTERISTICS

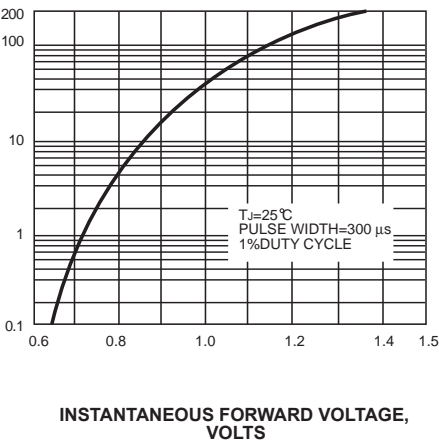

INSTANTANEOUS REVERSE CURRENT, MICROAMPERES

FIG. 4-TYPICAL REVERSE CHARACTERISTICS

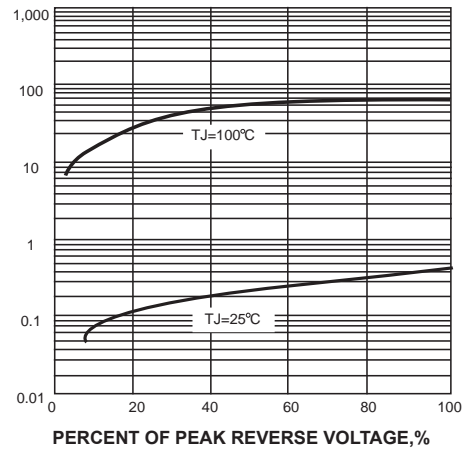

JUNCTION CAPACITANCE, pF

FIG. 5-TYPICAL JUNCTION CAPACITANCE

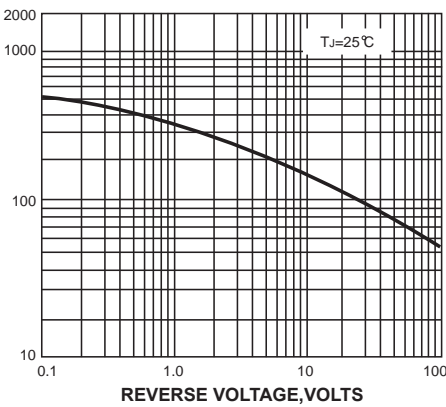

TRANSIENT THERMAL IMPEDANCE, °C/W

FIG. 6-TYPICAL TRANSIENT THERMAL IMPEDANCE

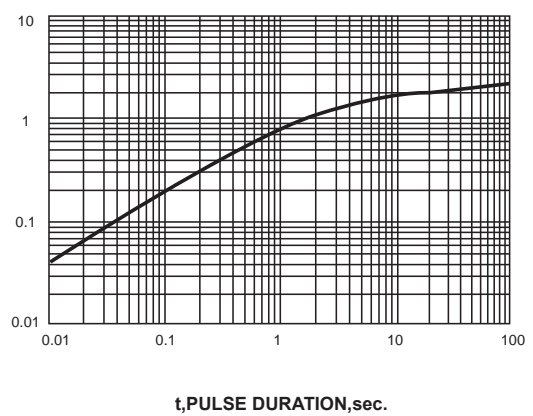

The curve above is for reference only.