

POWER RELAY

1 POLE—8 A (MEDIUM LOAD CONTROL)

JS SERIES

Lead Free / RoHS compliant*

FEATURES

- UL, CSA, VDE, SEV, SEMKO, FIMKO, ÖVE, BSI recognized
- UL class B (130°C) insulation
- 1 form A (SPST-NO) or 1 form C (SPDT) contact
- Low profile and space saving—Height: 12.5 mm
—Mounting space: 290 mm²
- High sensitivity in small package
—Operating power 0.11 to 0.14 W
—Nominal power 0.22 to 0.29 W
- High isolation in small package
—Insulation distance : 8 mm
—Dielectric strength : 5,000 VAC (between coil and contacts)
—Surge strength : 10,000 V
- Plastic materials—UL 94 flame class V-0
—UL CTI level class 2
- Plastic sealed type
- Lead Free since date code: 0438B9, 0434R - Please see page 6 for more information

* some part numbers still contain cadmium and are not RoHS compliant



ORDERING INFORMATION

[Example] JS - 12 M E - K T - V3
(a) (*) (b) (c) (d) (e) (f) (j)

勝特力材料 886-3-5753170
 胜特力电子(上海) 86-21-54151736
 胜特力电子(深圳) 86-755-83298787
[Http://www.100y.com.tw](http://www.100y.com.tw)

(a)	Series Name	JS : JS Series
(b)	Nominal Voltage	Refer to the COIL DATA CHART
(c)	Contact Arrangement	Nil : 1 form C (SPDT) M : 1 form A (SPST-NO)
(d)	Contact Material	Nil : Gold plate silver cadmium oxide D : Silver nickel E : Silver cadmium oxide F : Silver nickel gold overlay N : Silver tin oxide gold overlay
(e)	Enclosure	K : Plastic sealed type
(f)	Construction	Nil : 3.2 mm T : 5.0 mm (only JS-MN, MD, MF)
(j)	For low current application	Nil : 0.3μ gold overlay (available with Nil, N and F contact) V3: 3μ gold overlay for lower current applications (available with Nil, N and F contact)

Note: Actual marking omits the hyphen (-) of (*)

JS SERIES

■ SAFETY STANDARD AND FILE NUMBERS

UL508, 873 (File No. E56140, E108658)

C22.2 No. 14 (File No. LR35579)

VDE 0435, 0631, 0700 (File No. 11039-4940-1010)

勝特力材料 886-3-5753170
 勝特力电子(上海) 86-21-54151736
 勝特力电子(深圳) 86-755-83298787
[Http://www.100y.com.tw](http://www.100y.com.tw)

Nominal voltage	Contact rating
5 to 60 VDC	1/3 HP 125 VAC, 1/2 HP 250 VAC 10 A 30 VDC/250 VAC, resistive 3A 250 VAC inductive (PF = 0.4) Pilot duty B 300, C150

■ SPECIFICATIONS

1 - Contact material Silver Cadmium Oxide (AgCdO) type: Nil, E type

Item	JS ()-K	JS ()E-K	JS ()M-K	JS ()ME-K		
Contact	Arrangement		1 Form C (SPDT)		1 Form A (SPST-NO)	
	Material		Au+AgCdO	AgCdO	Au+AgCdO	AgCdO
	Resistance (initial)		30m Ohms (Au 3μm), 100m Ohms (Au 0.3μm) 1A 6 VDC			
	Rating		8A 250 VAC / 24 VDC			
	Max. carrying current		10A			
	Max. switching power		2,000VA/192W			
	Max. switching voltage		150VDC/400VAC			
	Min. switching load		10mA 5VDC			
	Max. switching current		10A			
Coil	Operating temperature		-40° C to +85° C (no frost)			
Time value	Operate		Max. 10ms (at nominal voltage, without bounce)			
	Release (without diode)		Max. 5ms (at nominal voltage, without bounce)			
Insulation	Resistance (at 500VDC)		Min. 1,000 Mohms			
	Dielectric Strength	B/T contacts	1,000VAC, 1 minute			
		B/T coil and contacts	4,000VAC, 1 minute			
Surge strength		10,000V (at1.2x50 μsec.)				
Life	Mechanical		20x10 ⁶ operations minimum			
	Electrical (resistive load)		100x10 ³ operations min.			
Vibration resistance	Misoperation		10 to 55 Hz at double amplitude of 1.65mm			
	Endurance		10 to 55 Hz at double amplitude of 3.3mm			
Shock resistance	Misoperation		Min. 200m/s ² (11±1ms)			
	Endurance		Min. 1,000m/s ² (6±1ms)			
Weight		Approx. 8g				

勝特力材料 886-3-5753170
 勝特力电子(上海) 86-21-54151736
 勝特力电子(深圳) 86-755-83298787
[Http://www.100y.com.tw](http://www.100y.com.tw)

2 - Contact material Silver Tin Oxide (AgSnO₂) type: N type

Item		JS ()N-K	JS ()MN-K	JS ()MN-KT
Contact	Arrangement	1 Form C	1 Form A	
	Material	Au+AgSnO ₂		
	Resistance (initial)	Max. 100 mohms (at 1A 6 VDC)		
	Rating	8A 250 VAC / 24 VDC		
	Max. carrying current	10A		
	Max. switching power	2,000VA/192W		
	Max. switching voltage	150VDC/400VAC		
	Min. switching load	10mA 5VDC		
	Max. switching current	10A		
Coil	Operating temperature	-40° C to +85° C (no frost)		
Time value	Operate	Max. 10ms (at nominal voltage, without bounce)		
	Release (without diode)	Max. 5ms (at nominal voltage, without bounce)		
Insulation	Resistance (at 500VDC)	Min. 1,000 Mohms		
	Dielectric Strength	B/T contacts	1,000VAC, 1 minute	
		B/T coil and contacts	4,000VAC, 1 minute	
Surge strength	10,000V (at1.2x50 μsec.)			
Life	Mechanical	20x10 ⁶ operations minimum		
	Electrical (resistive load)	50x10 ³ ops. min.	100x10 ³ ops. min.	
Vibration resistance	Misoperation	10 to 55 Hz at double amplitude of 1.65mm		
	Endurance	10 to 55 Hz at double amplitude of 3.3mm		
Shock resistance	Misoperation	Min. 200m/s ² (11±1ms)		
	Endurance	Min. 1,000m/s ² (6±1ms)		
Weight		Approx. 8g		

勝特力材料 886-3-5753170
 勝特力电子(上海) 86-21-54151736
 勝特力电子(深圳) 86-755-83298787
[Http://www.100y.com.tw](http://www.100y.com.tw)

JS SERIES

3 - Contact material Silver Nickel (AgNi) type: D, F type

Item		JS ()F-K	JS ()D-K	JS ()MF-K JS ()MF-KT	JS ()MD-K JS ()MD-KT
Contact	Arrangement	1 Form C		1 Form A	
	Material	Au+AgNi	AgNi	Au+AgNi	AgNi
	Resistance (initial)	30m Ohms (Au 3μm), 100m Ohms (Au 0.3μm) 1A 6 VDC			
	Rating	8A 250 VAC / 24 VDC			
	Max. carrying current	10A			
	Max. switching power	2,000VA/192W			
	Max. switching voltage	150VDC/400VAC			
	Min. switching load	10mA 5VDC			
	Max. switching current	10A			
Coil	Operating temperature	-40° C to +85° C (no frost)			
Time value	Operate	Max. 10ms (at nominal voltage, without bounce)			
	Release (without diode)	Max. 5ms (at nominal voltage, without bounce)			
Insulation	Resistance (at 500VDC)	Min. 1,000 Mohms			
	Dielectric Strength	B/T contacts	1,000VAC, 1 minute		
		B/T coil and contacts	4,000VAC, 1 minute		
	Surge strength	10,000V (at 1.2x50 μsec.)			
Life	Mechanical	20x10 ⁶ operations minimum			
	Electrical (resistive load)	20x10 ³ operations min.			
Vibration resistance	Misoperation	10 to 55 Hz at double amplitude of 1.65mm			
	Endurance	10 to 55 Hz at double amplitude of 3.3mm			
Shock resistance	Misoperation	Min. 200m/s ² (11±1ms)			
	Endurance	Min. 1,000m/s ² (6±1ms)			
Weight	Approx. 8g				

*1 Minimum switching loads mentioned above are reference values. Please perform the confirmation test with the actual load before production since reference values may vary according to switching frequencies, environmental conditions and expected reliability levels.

COIL DATA CHART

MODEL	Nominal voltage	Coil resistance (±10%)	Must operate voltage	Must release voltage	Nominal power
JS- 5(M)(NIL,E,N,D,F)-K(T)	5 VDC	112Ω	3.5 VDC	0.5 VDC	225 mW
JS- 6(M)(NIL,E,N,D,F)-K(T)	6 VDC	160Ω	4.2 VDC	0.6 VDC	225 mW
JS- 9(M)(NIL,E,N,D,F)-K(T)	9 VDC	360Ω	6.3 VDC	0.9 VDC	225 mW
JS-12(M)(NIL,E,N,D,F)-K(T)	12 VDC	660Ω	8.5 VDC	1.2 VDC	220 mW
JS-18(M)(NIL,E,N,D,F)-K(T)	18 VDC	1,455Ω	12.7 VDC	1.8 VDC	225 mW
JS-24(M)(NIL,E,N,D,F)-K(T)	24 VDC	2,350Ω	16.8 VDC	2.4 VDC	245 mW
JS-48(M)(NIL,E,N,D,F)-K(T)	48 VDC	8,000Ω	33.4 VDC	4.8 VDC	290 mW
JS-60(M)(NIL,E,N,D,F)-K(T)	60 VDC	12,500Ω	41.7 VDC	6.0 VDC	290 mW

Note : All values in the table are measured at 20°C.

CHARACTERISTIC DATA

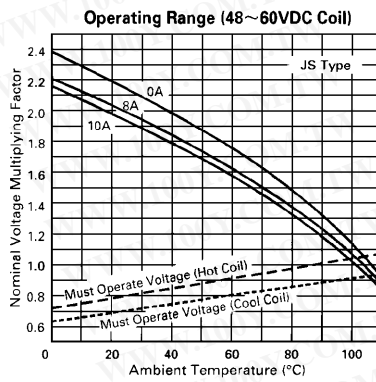
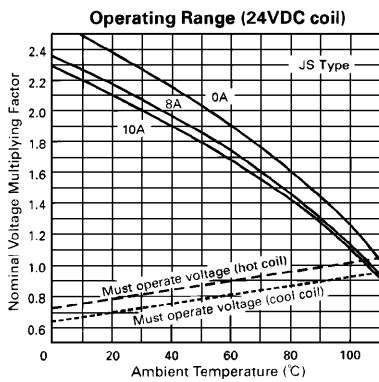
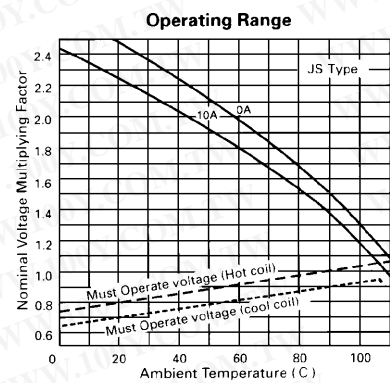
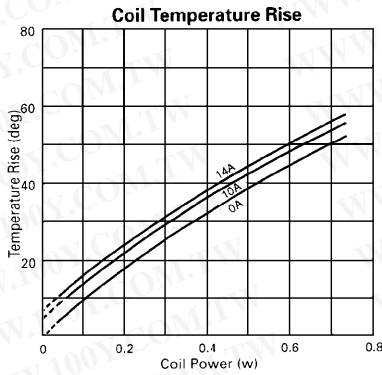
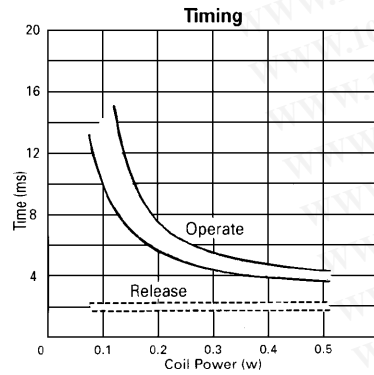

Maximum Switching Power

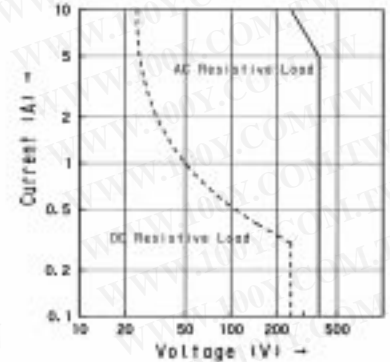

Life Curves

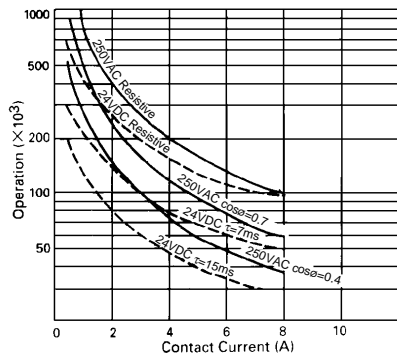

REFERENCE DATA

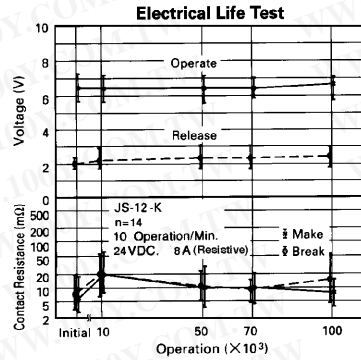
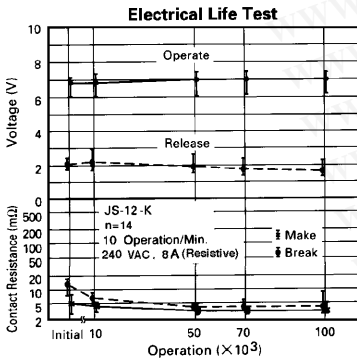
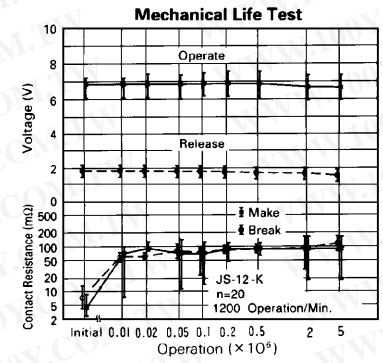
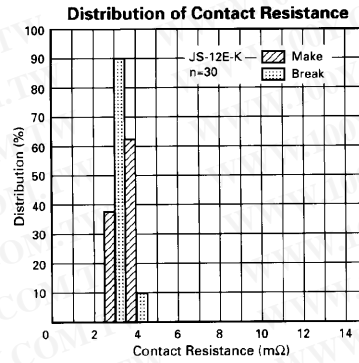
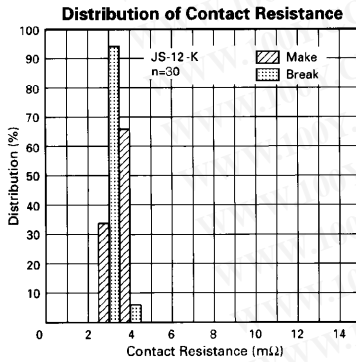
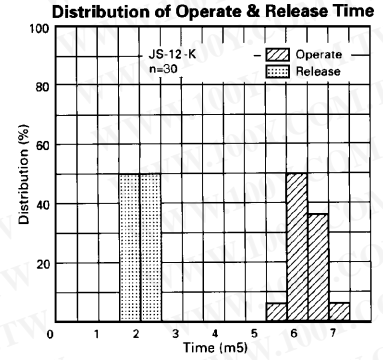
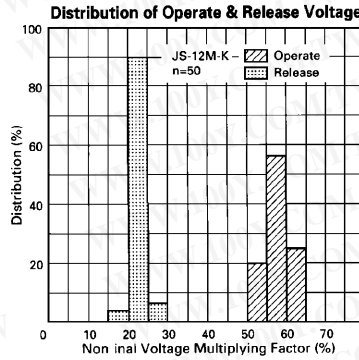
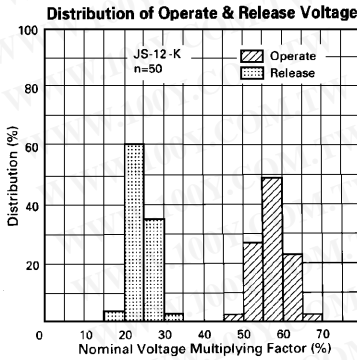

■ DIMENSIONS

● Dimensions

JS-MK type

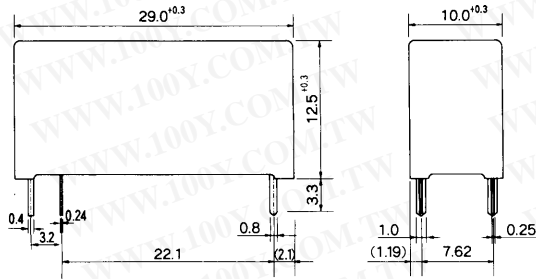

● Schematics (BOTTOM VIEW)



● PC board mounting hole layout (BOTTOM VIEW)

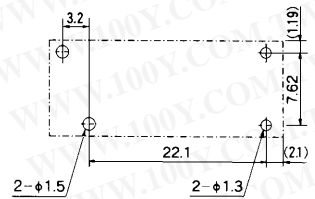

JS-K type

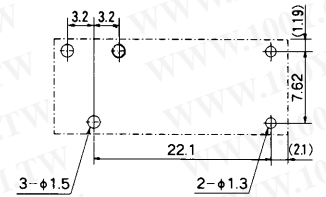
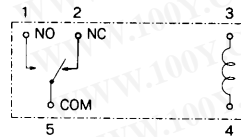
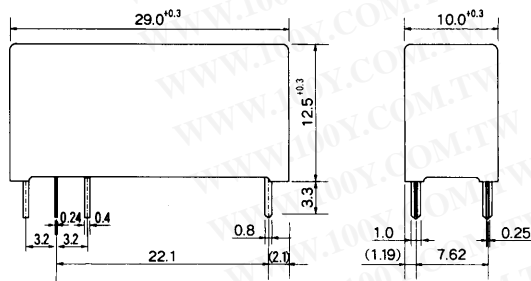

JS-M(-)-KT type

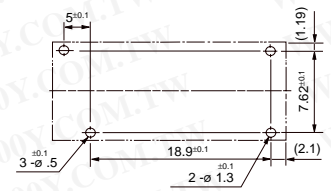
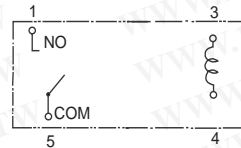
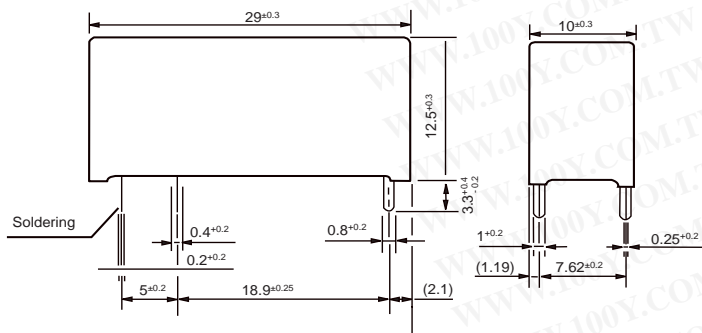

Unit: mm

RoHS Compliance and Lead Free Relay Information

1. General Information

- Relays produced after the specific date code that is indicated on each data sheet are lead-free now. Most of our signal and power relays are lead-free. Please refer to Lead-Free Status Info. (<http://www.fcai.fujitsu.com/pdf/LeadFreeLetter.pdf>)
- Lead free solder paste currently used in relays is Sn-3.0Ag-0.5Cu. From February 2005 forward Sn-3.0Cu-Ni will be used for FTRB3 and FTR-B4 series relays.
- Most signal and some power relays also comply with RoHS. Please refer to individual data sheets. Relays that are RoHS compliant do not contain the 6 hazardous materials that are restricted by RoHS directive (lead, mercury, cadmium, chromium IV, PBB, PBDE).
- It has been verified that using lead-free relays in lead assembly process will not cause any problems (compatible).
- "LF" is marked on each outer and inner carton. (No marking on individual relays).
- To avoid leaded relays (for lead-free sample, etc.) please consult with area sales office. We will ship leaded relays as long as the leaded relay inventory exists.

2. Recommended Lead Free Solder Profile

- Recommended solder paste Sn-3.0Ag-0.5Cu and Sn-3.0 Cu-Ni (only FTR-B3 and FTR-B4 from February 2005)

Reflow Solder condition

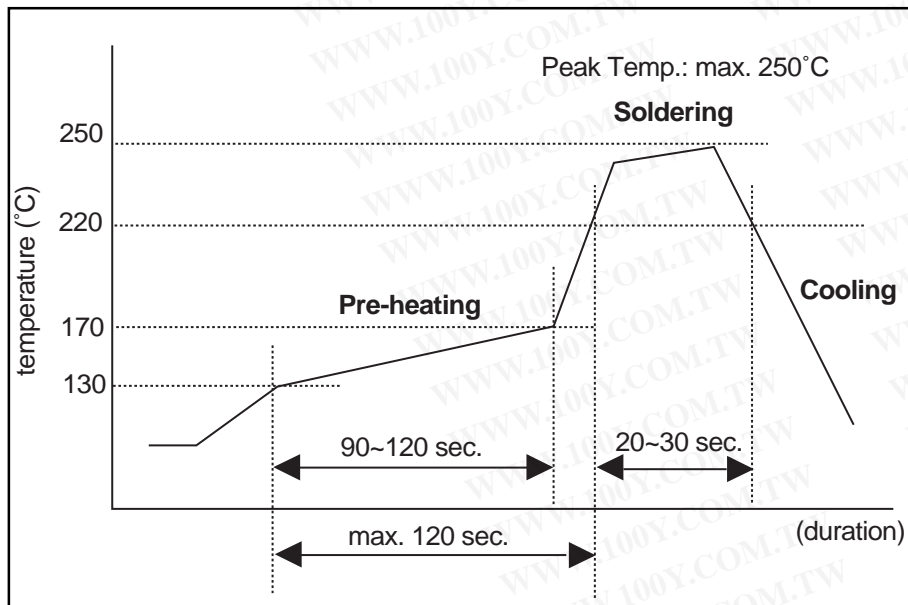

Flow Solder condition:

Pre-heating: maximum 120°C
 Soldering: dip within 5 sec. at 260°C solder bath

Solder by Soldering Iron:

Soldering Iron
 Temperature: maximum 360°C
 Duration: maximum 3 sec.

We highly recommend that you confirm your actual solder conditions

3. Moisture Sensitivity

- Moisture Sensitivity Level standard is not applicable to electromechanical relays.

4. Tin Whisker

- SnAgCu solder is known as low risk of tin whisker. No considerable length whisker was found by our in-house test.

5. Solid State Relays

- Each lead terminal will be changed from solder plating to Sn plating and Nickel plating. A layer of Nickel plating is between the terminal and the Sn plating to avoid whisker.