

1 | 2 | 3 | 4

A

-VAY3

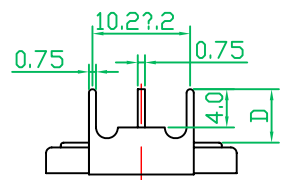
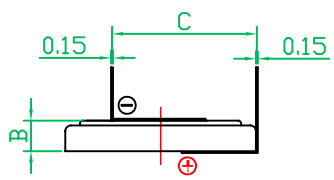
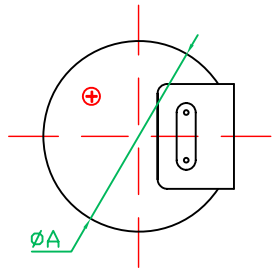

A

B

-VBY2

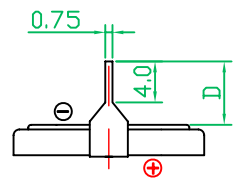
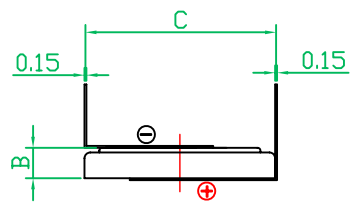
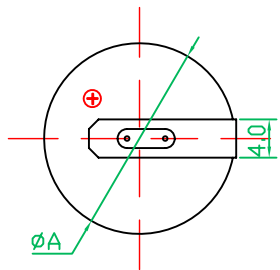

B

C

-VCY2

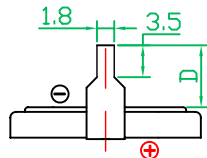
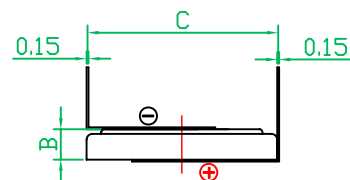
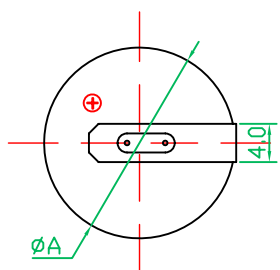

C

D

-VDY2

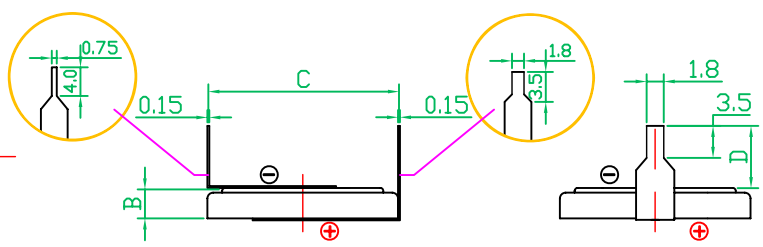
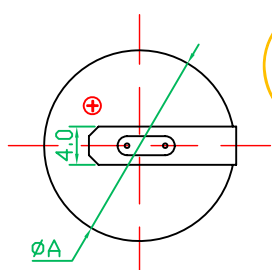

D

E

-VFY2

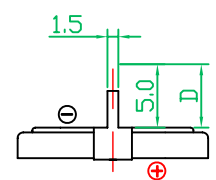
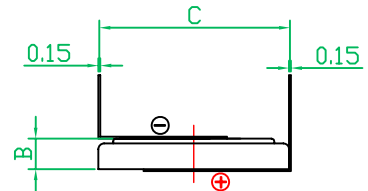
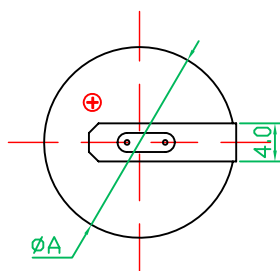

E

F

-VGY2

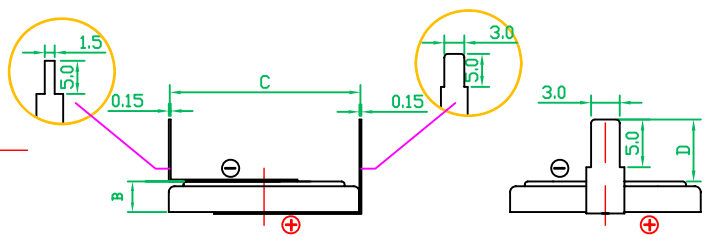
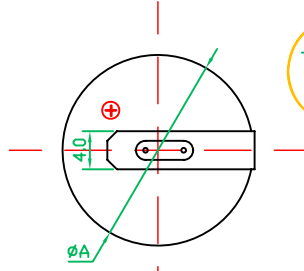

F

1 | 2 | 3 | 4

1

2

3

4

A

-PAN3

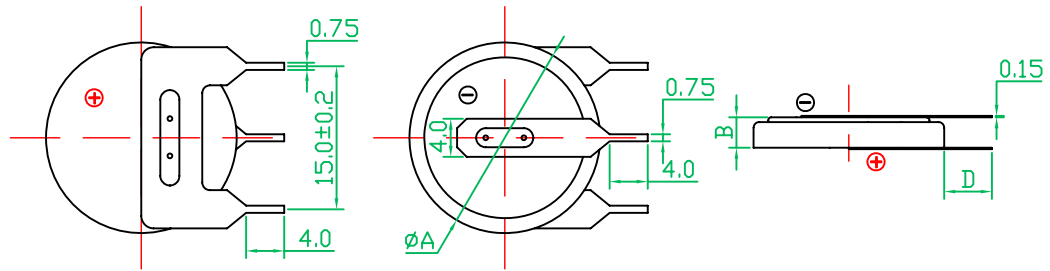

A

B

-PBN2

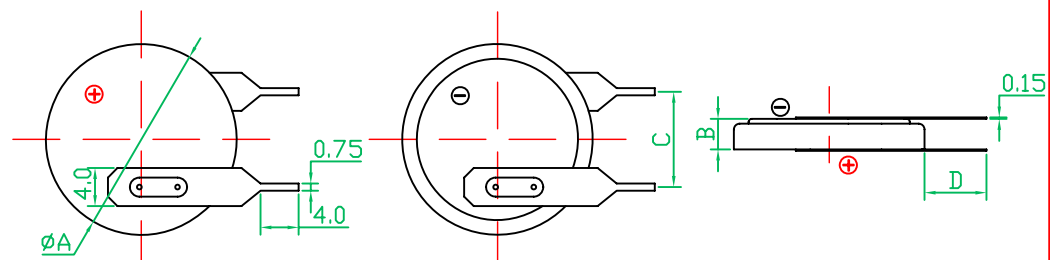

B

C

-PCN2

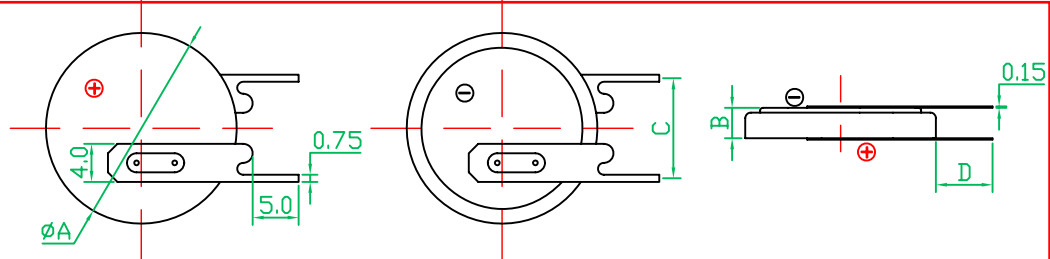

C

D

-PDY2

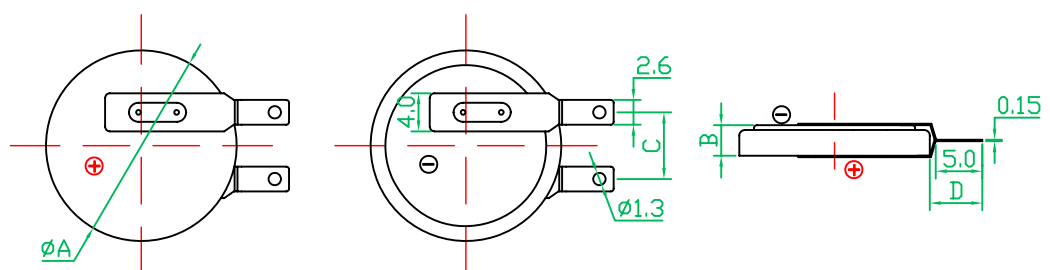

D

E

-PEN3

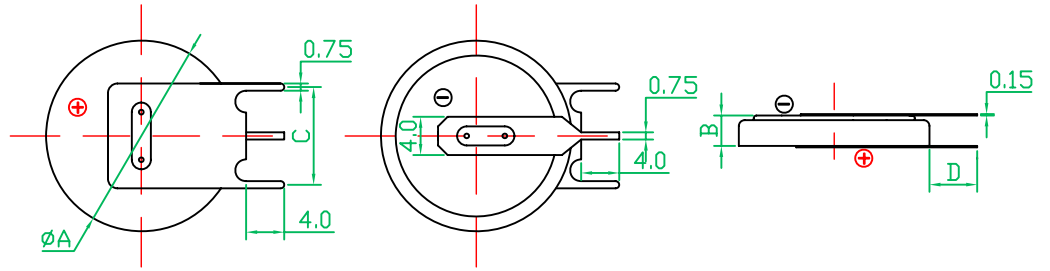

E

F

-PFN2

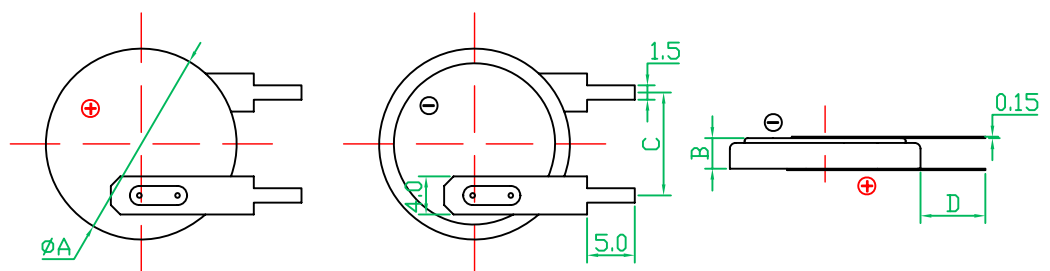

F

1

2

3

4

	1	2	3	4	
A	-PGY2				A
B	-PHY2				B
C	-PIY2				C
D	-PJY2				D
E	-PKY2				E
F	-SAN2				F
	1	2	3	4	

1

2

3

4

A

-SBN2

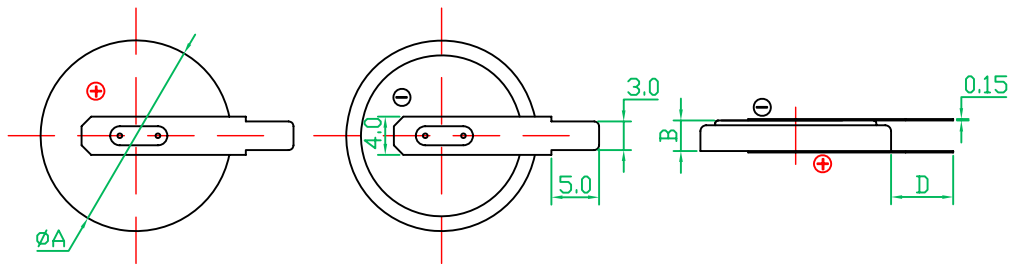

A

B

-SCN2

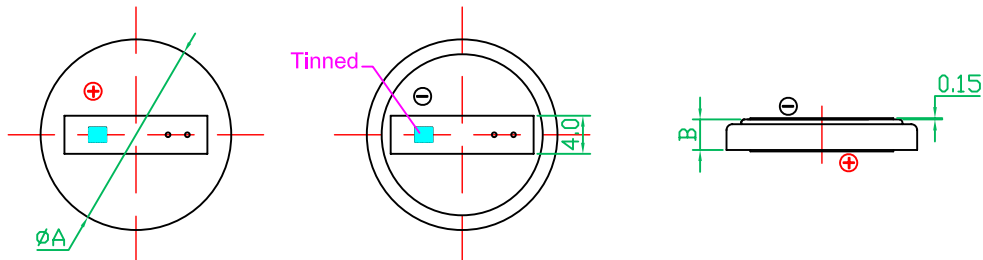

B

C

-SDN3

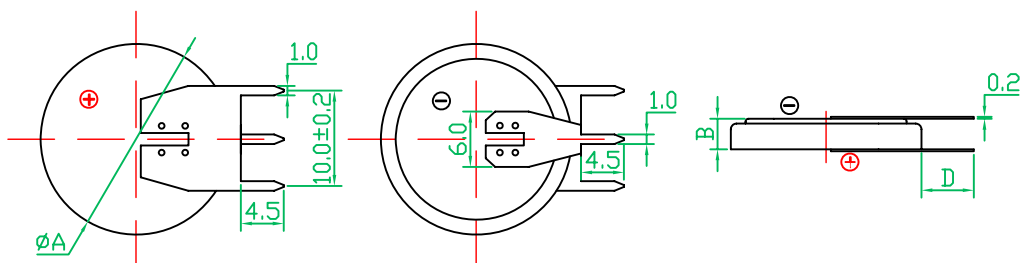

C

D

-LAN2

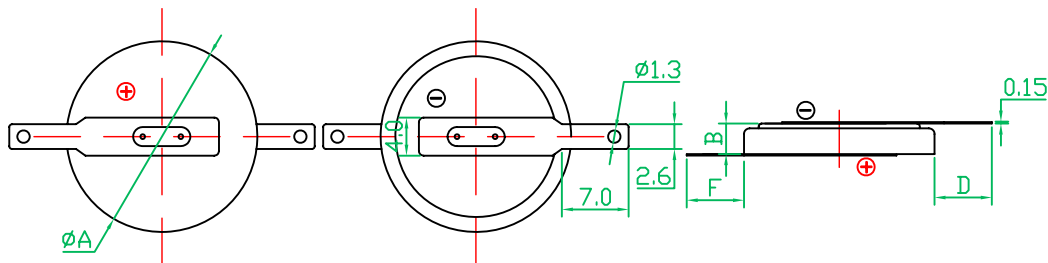

D

E

-LBY2

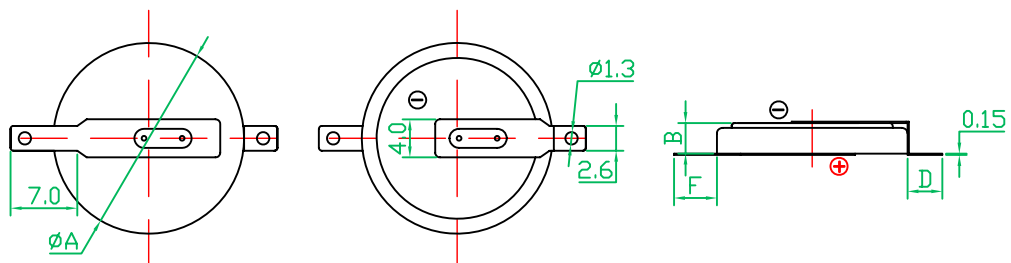

E

F

-LCY2

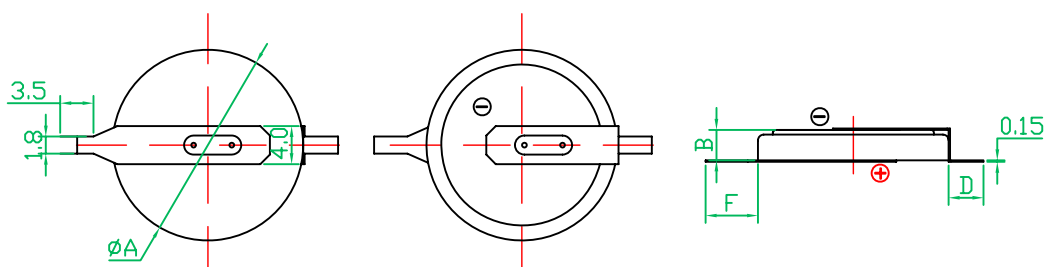

F

1

2

3

4

1

2

3

4

A

-LDY2

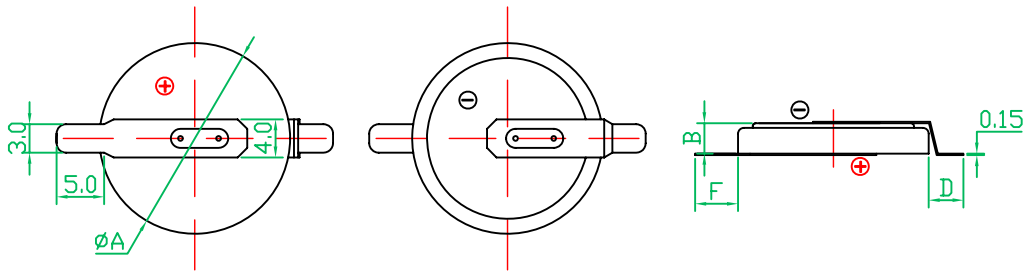

A

B

-LEY2

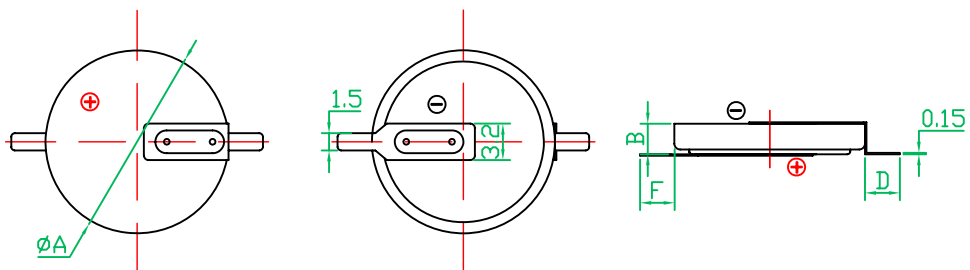

B

C

-LFY2

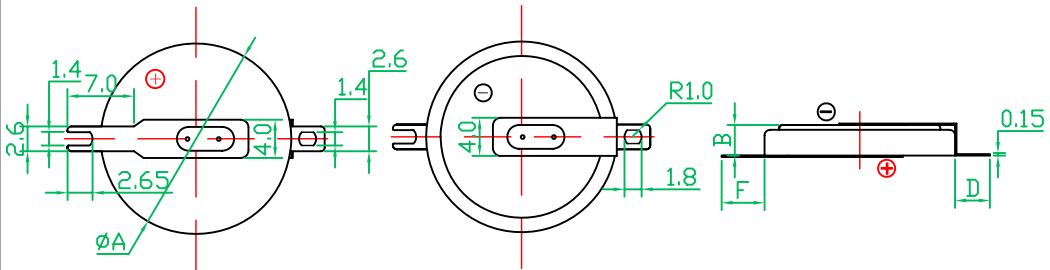

C

D

-LGY2

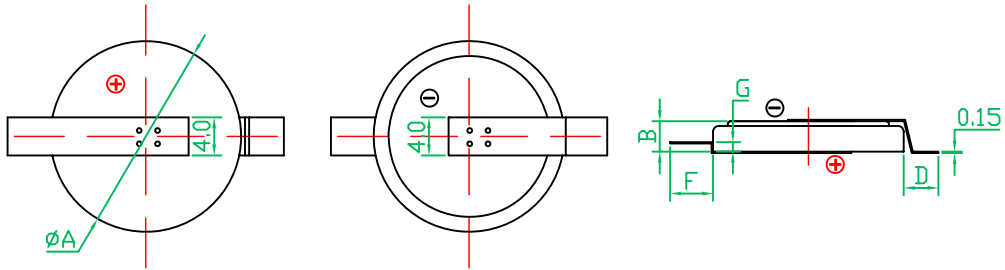

D

E

-AAAY2

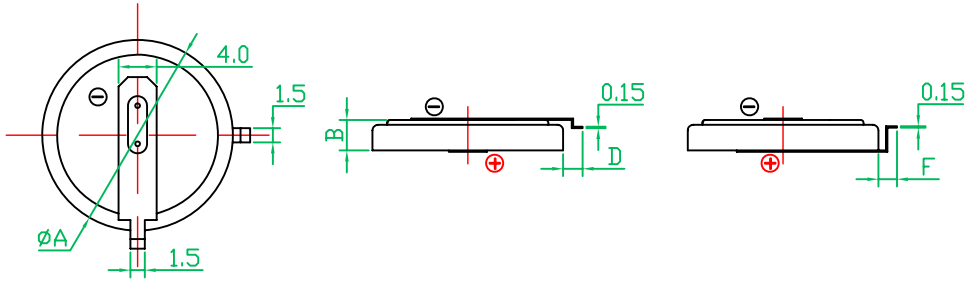

E

F

-ABY2

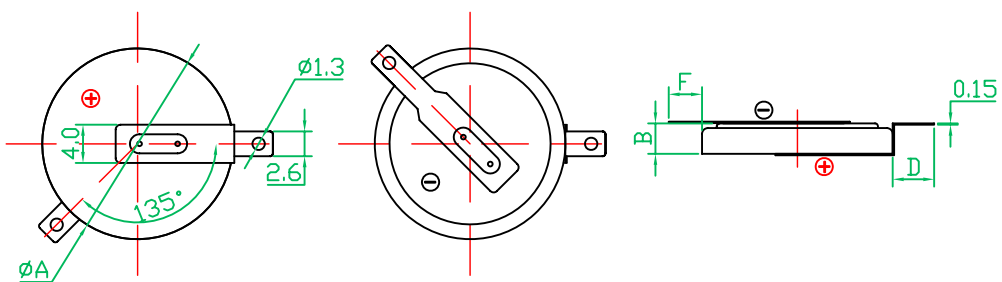

F

1

2

3

4

1
A
-ADY2

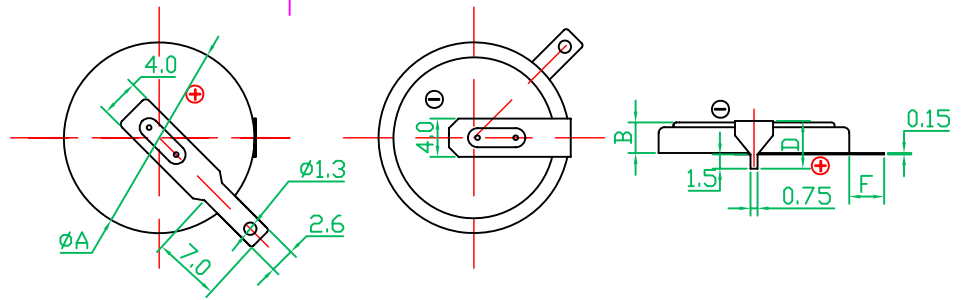

B
-AFY2

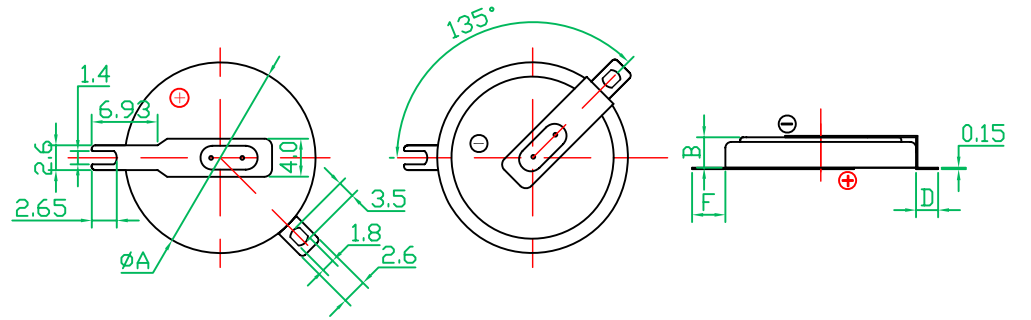

C
-LD

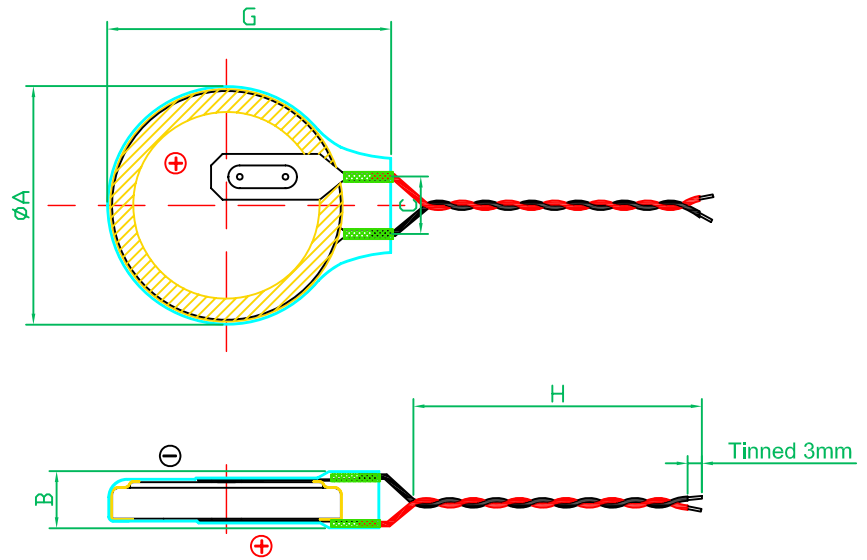

E
-LD/

