

BS5 Series

Photo micro sensor BS5 series

■ Features

- Micro amp built in, NPN open collector output
- Various selection by installation position
(Appearance: K, T, L Type)
- Light ON / Dark ON switching operation mode
- High speed response frequency : 2kHz
- Wide range of power source: 5–24VDC
(Easy to connect with various IC, relay, PLC etc)
- Strong structure for dust: Protecting by window of Emitter/ Receiver
- Enable to check the status of operation by Red indicator

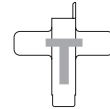

T2M



L2M

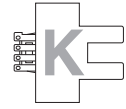

K2M

 Please read "Caution for your safety" in operation manual before using.



■ Specifications

Type	Photo micro sensor		
Model	BS5-K2M	BS5-T2M	BS5-L2M
Detecting distance	Fixed 5mm		
Detecting type	Through-beam (Not modulated)		
Detecting target	Opaque material of Min. 0.8 × 1.8mm		
Hysteresis	0.05mm		
Power supply	5–24VDC ±10% (Ripple P–P : Max. 10%)		
Current consumption	Max. 30mA (at 26.4VDC)		
Control output	NPN open collector output ⇒ Load voltage : Max. 30VDC, Load current : Max. 100mA Residual voltage : Max. 1.2V		
Operation mode	Selectable Light ON / Dark ON mode by control wire		
Operation indicator	Red LED		
Response time	Received light : Max. 20μs, Interrupted light : Max. 100μs		
Response frequency	2kHz (Please see the measuring range of frequency response)		
Connection	Connector type		
Light source	Infrared LED (RED)		
Light receiving element	Photo TR		
Vibration	1.5mm amplitude at frequency of 10 ~ 55Hz in each of X, Y, Z directions for 2 hours		
Shock	500m/s ² (50G) in X, Y, Z directions for 3 times		
Noise strength	±240V the square wave noise (pulse width: 1μs) by the noise simulator		
Dielectric strength	1,000VAC 50/60Hz for 1minute		
Insulation resistance	Min. 20MΩ (at 250VDC)		
Ambient illumination	Fluorescent lamp : Max. 1000lx		
Ambient temperature	–20 ~ + 55°C (at non-freezing status), Storage : –25 ~ + 85°C		
Ambient humidity	35 ~ 85%RH (Storage : 35 ~ 85%RH)		
Protection	IP50 (IEC specification)		
Approval			
Material	PBT		
Weight	Approx. 30g		

Photo Micro Sensor

Control output diagram

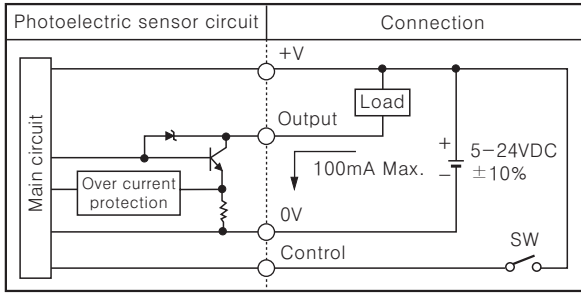

How to measure response frequency

Response frequency value is from revolving of below circle panel.

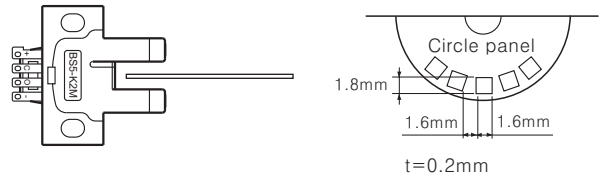

Operation mode

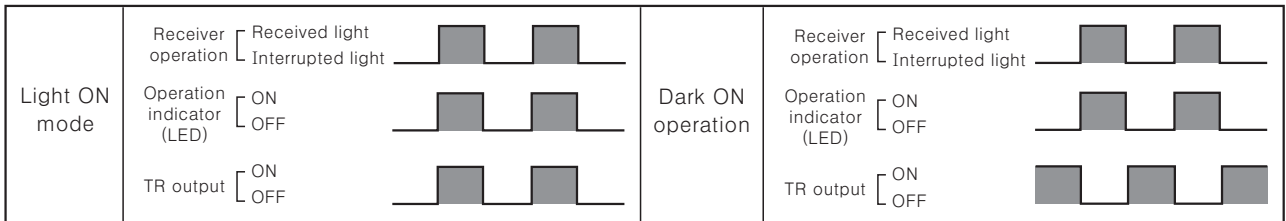

※ If the control output terminal is short-circuited or if over current condition exists, the control output will turn off due to protection circuit.

Connections

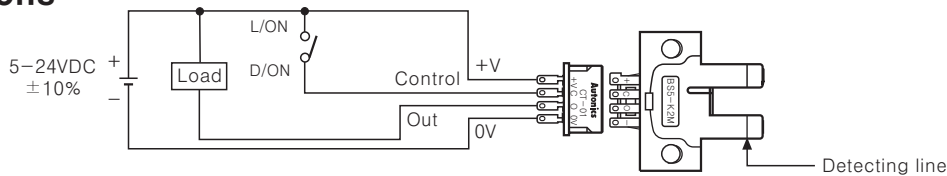

Dimensions

BS5-K2M

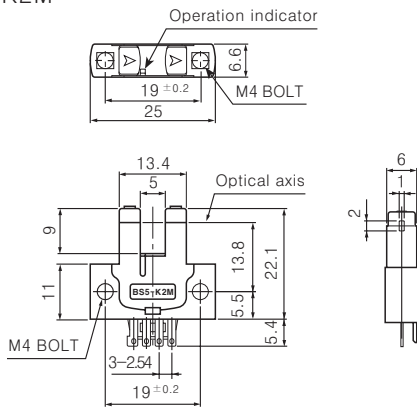

BS5-T2M

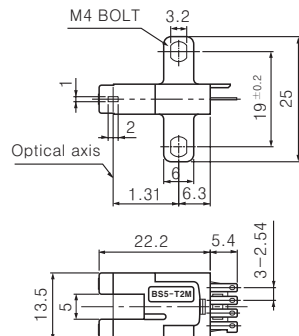

BS5-L2M

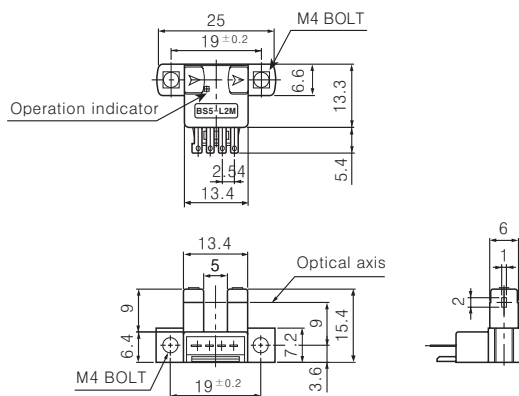

Socket : CT-01 (Option)

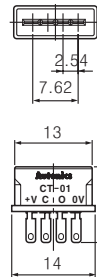

Socket : CT-02 (Option)

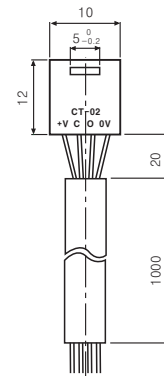

PCB mounting hole

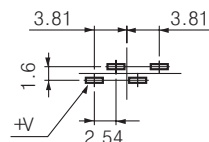

※ The cable length is optional.

Unit:mm

(A) Counter

(B) Timer

(C) Temp. controller

(D) Power controller

(E) Panel meter

(F) Tacho/Speed/Pulse meter

(G) Display unit

(H) Sensor controller

(I) Proximity sensor

(J) Photo electric sensor

(K) Pressure sensor

(L) Rotary encoder

(M) 5-Phase stepping motor & Driver & Controller